

Series
VENTS VKV
VENTS VKVz
VENTS VKVA

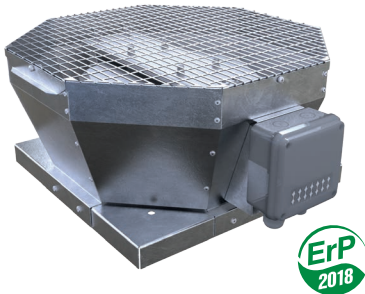

Series
VENTS VKH
VENTS VKHz

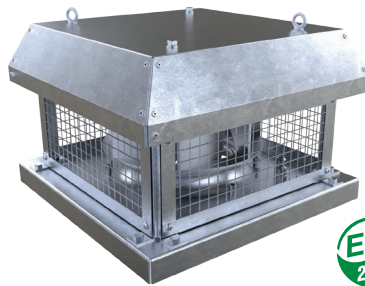

Centrifugal roof fans with vertical air exhaust and with maximum air flow of up to **17010 m³/h**

Centrifugal roof fans with horizontal air exhaust and with maximum air flow of up to **17010 m³/h**



VENTS VKV



VENTS VKH

■ **Application**

Exhaust ventilation systems for commercial, office and other public or industrial premises for various premises suitable for roof mounting. Compatible with Ø 200-630 mm air ducts. Suitable for any roof types as well as vertical ventilation shafts.

■ **Design**

The fan casing is made of steel with polymeric coating (VENTS VKV and VENTS VKH models), aluminum (VENTS VKVA), galvanized steel (VENTS VKVz, VENTS VKHz).

■ **Motor**

2-, 4- or 6-pole single- or three-phase asynchronous motors with an external rotor and impeller with backward curved blades. The motor is equipped with thermal overheating protection with automatic restart as well as ball bearings for long service life. For precise features, safe operation and low noise, each turbine is dynamically balanced while assembly. Motors protection rating IP44, IP54.

■ **Speed control**

Both smooth or step speed control is performed by means of the thyristor or autotransformer controller. Several fans can be connected to one controller in case the total power and operating current do not exceed the rated controller values.

■ **Mounting**

The fan is mounted on the roof directly above the ventilating duct or shaft and is firmly fixed to the flat surface by means of a connecting plate. While mounting VKH fans directly onto the flat roof a supporting block shall be provided to prevent water and snow drops into the vent of the ventilation shaft. Electrical connection and installation shall be performed in compliance with the manual and circuit diagram on the terminal box.

For connection of the fans to round air ducts use the following accessories: KKV damper, GVK flexible connector, FKV counter flange. For mounting of the fans to flat surface use the mounting frame RKV.

Designation key

Series and modification	Casing material	Motor modification		Turbine standard size
		Number of poles	Phase	
VENTS VKV: vertical air exhaust VENTS VKH: horizontal air exhaust	_: steel with polymeric coating A: aluminum z: galvanized steel	2 4 6	E: single-phase D: three-phase	190; 220; 225; 250; 280; 310; 355; 400; 450; 500; 560; 630; 710

Accessories



Flexible connector

Counterflange

Mounting frame

Silencers

Backdraft damper

Air shutter

Speed controllers

Fan overall dimensions

Type	Dimensions [mm]			øD, flange connection dimensions	Mass [kg]
	A	B	C		
VKV/VKVz/VKVA 2E 190	417	355	170	213	7
VKV/VKVz/VKVA 2E 220*			190		
VKV/VKVz/VKVA 2E 225*			215		
VKV/VKVz/VKVA 4E 225*	481	425	240	285	9
VKV/VKVz/VKVA 2E 250			240		
VKV/VKVz/VKVA 4E 250			276		
VKV/VKVz/VKVA 4E 280	547	425	276	291	13
VKV/VKVz/VKVA 2E 310			276		
VKV/VKVz/VKVA 4E 310*			300		
VKV/VKVz/VKVA 4D 310*	613	477	300	285	20
VKV/VKVz/VKVA 4E 355			300		
VKV/VKVz/VKVA 4D 355			300		
VKV/VKVz 4E 400	738	598	375	438	33
VKV/VKVz 6E 400			375		
VKV/VKVz 4D 400			375		
VKV/VKVz 4E 450	859	668	430	445	41
VKV/VKVz 6E 450			430		
VKV/VKVz 4D 450			425		
VKV/VKVz 6E 500*	859	668	460	445	52
VKV/VKVz 4D 500*			460		
VKV/VKVz 6D 500*			460		
VKV/VKVz 6E 560	951	939	485	605	63
VKV/VKVz 4D 560			485		
VKV/VKVz 6D 560			485		
VKV/VKVz 6D 630*	951	939	485	600	81
VKV/VKVz 6D 710*	992	939	485	674	114

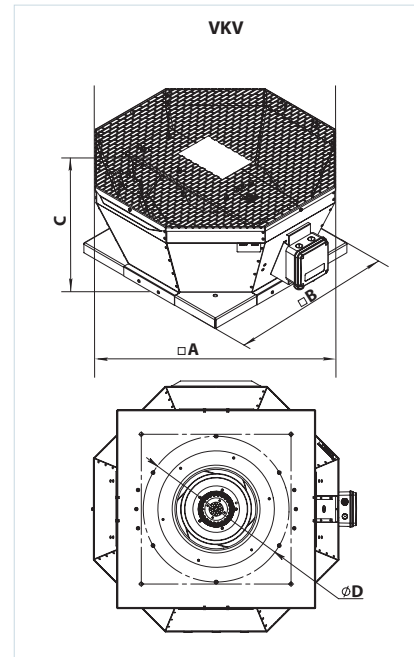

*The counter flange (not included in the delivery set) should be mounted together with the inlet ring.

Fan overall dimensions

Type	Dimensions [mm]						øD, flange connection dimensions	Mass [kg]
	H	H1	A	B	C	Ød		
VKH/VKHz 2E 190	189	195	351	350	245	11	213	8.2
VKH/VKHz 2E 220	180	186	337	338				7
VKH/VKHz 2E 225	210	217	351	350				9.2
VKH/VKHz 4E 225	233	240	351	350	11	210	8.8	
VKH/VKHz 2E 250	237	244	451	450	330	11	285	12.7
VKH/VKHz 4E 250	237	244						12.1
VKH/VKHz 4E 280	265	272						13.5
VKH/VKHz 2E 310	251	258	451	450	330	11	291	13.2
VKH/VKHz 4E 310	287	294						14.2
VKH/VKHz 4D 310	287	294						14.2
VKH/VKHz 4E 355	322	361	625	620	450	11	438	28.3
VKH/VKHz 4D 355	347	386						30.3
VKH/VKHz 4E 400	376	415						35
VKH/VKHz 6E 400	376	415	625	620	450	11	438	32.7
VKH/VKHz 4D 400	376	415						35
VKH/VKHz 4E 450	420	459						46.6
VKH/VKHz 6E 450	420	459	710	700	535	11	438	45.6
VKH/VKHz 4D 450	461	501						45.5
VKH/VKHz 6E 500	461	501						52.8
VKH/VKHz 4D 500	490	530	710	700	535	11	438	46.6
VKH/VKHz 6D 500	461	501						52.7
VKH/VKHz 6E 560	489	528						76.4
VKH/VKHz 4D 560	489	528	900	895	750	11	605	81.4
VKH/VKHz 6D 560	489	528	900	895	750	11	605	76.4
VKH/VKHz 6D 630	520	560	1000	990	20	20	674	96.3
VKH/VKHz 6D 710	570	619	1060	1050	840	20	674	134

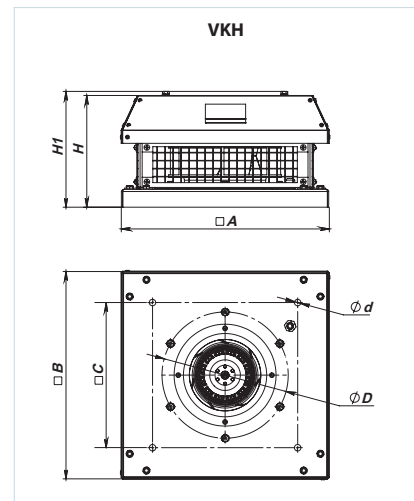

VENTS
VKV/VKH
FAN SERIES

Technical data

	VKV/VKVz/VKVA/ VKH/VKHz 2E 190		VKV/VKVz/VKVA/ VKH/VKHz 2E 220	
Voltage [V]	1~230		1~230	
Frequency [Hz]	50	60	50	60
Power [W]	69	89	108	118
Current [A]	0.30	0.40	0.49	0.54
Max. air flow [m ³ /h]	610	654	880	883
RPM [min ⁻¹]	2680	2980	2580	2840
Sound pressure level at 3 m [dBA]	48	49	50	51
Transported air temperature [°C]	-25...+50		-25...+50	
Protection rating	IPX4		IPX4	
Motor protection rating	IP44		IP44	
SEC class	C	-	C	-

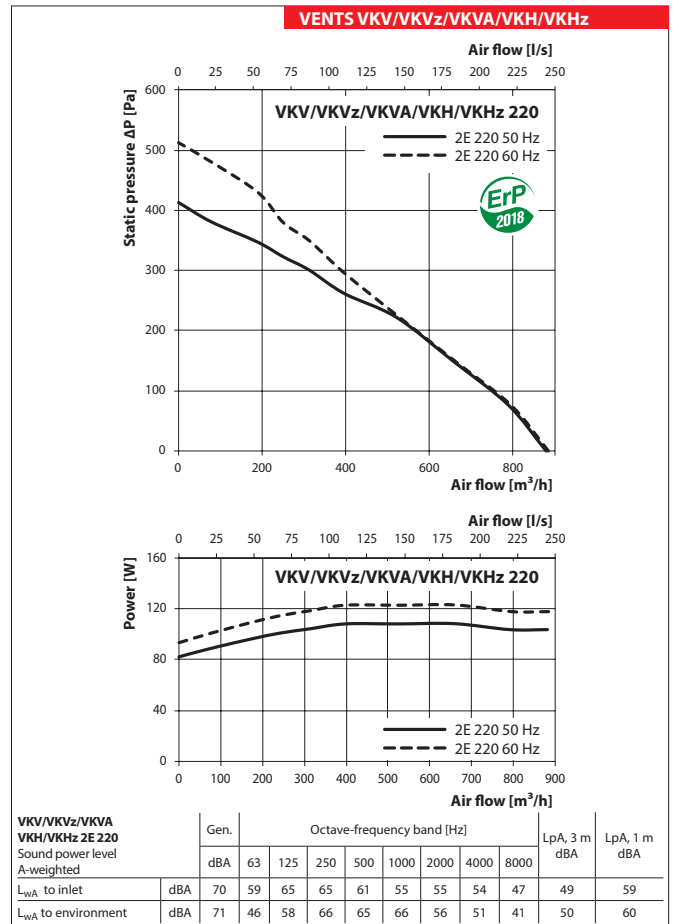
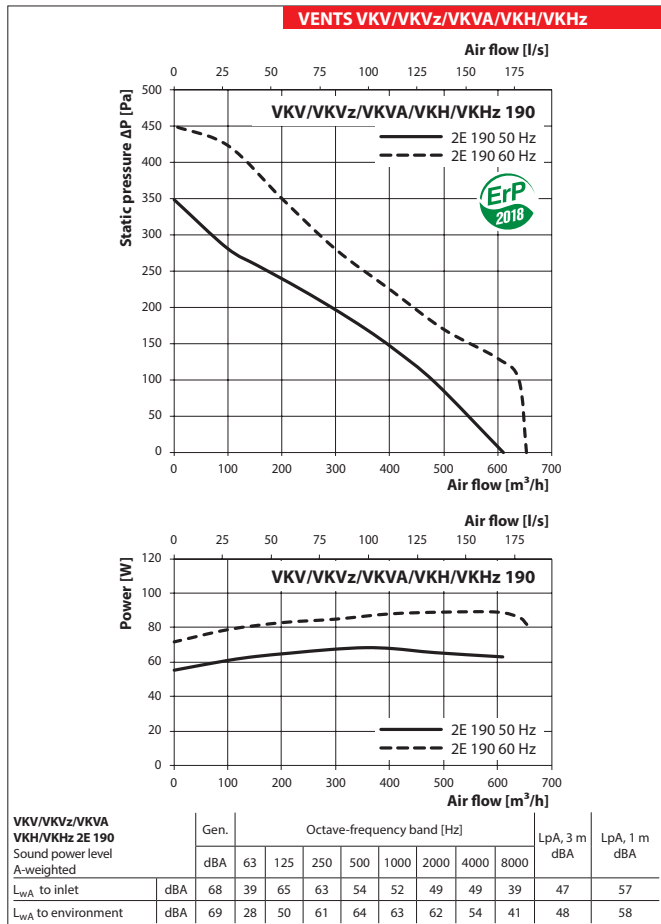

Technical data

	VKV/VKVz/VKVA/ VKH/VKHz 2E 225		VKV/VKVz/VKVA/ VKH/VKHz 4E 225		VKV/VKVz/VKVA/ VKH/VKHz 2E 250		VKV/VKVz/VKVA/ VKH/VKHz 4E 250	
Voltage [V]	1~230		1~230		1~230		1~230	
Frequency [Hz]	50	60	50		50	60		50
Power [W]	123	169	49		184	232		48
Current [A]	0.54	0.70	0.22		0.81	0.90		0.23
Max. air flow [m ³ /h]	915	1 010	738		1 450	1 320		820
RPM [min ⁻¹]	2790	2820	1400		2480	2320		1440
Sound pressure level at 3 m [dBA]	51	52	45		54	53		46
Transported air temperature [°C]	-25...+50		-25...+50		-25...+50		-25...+50	
Protection rating	IPX4		IPX4		IPX4		IPX4	
Motor protection rating	IP44		IP44		IP44		IP44	
SEC class	C		-		B		-	

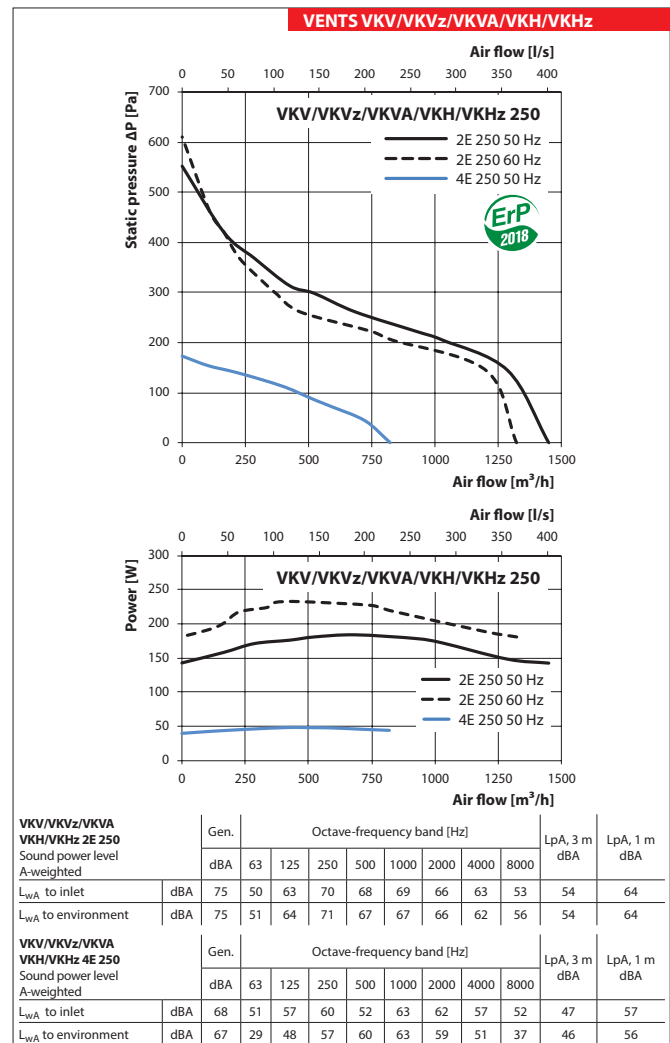
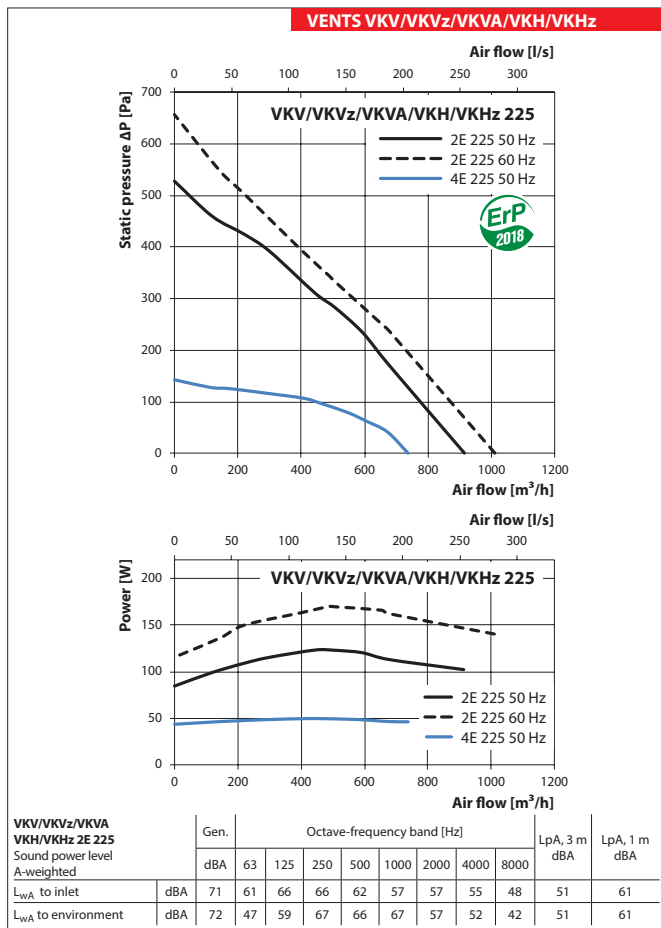

VENTS
FAN SERIES
VKV/VKH

Technical data

	VKV/VKVz/VKVA/ VKH/VKHz 4E 280		VKV/VKVz/VKVA/ VKH/VKHz 2E 310		VKV/VKVz/VKVA/ VKH/VKHz 4E 310		VKV/VKVz/VKVA/ VKH/VKHz 4D 310	
Voltage [V]	1~230		1~230		1~230		3~400	
Frequency [Hz]	50	60	50	50	60	50	60	
Power [W]	125	155	324	141	195	155	202	
Current [A]	0.61	0.99	1.42	0.64	0.87	0.29	0.32	
Max. air flow [m ³ /h]	1 490	1 520	2 150	2 265	2 425	2 300	2 442	
RPM [min ⁻¹]	1446	1710	2620	1420	1740	1410	1550	
Sound pressure level at 3 m [dBA]	46	46	58	47	49	47	48	
Transported air temperature [°C]	-25...+50		-25...+50		-25...+50		-25...+50	
Protection rating	IPX4		IPX4		IPX4		IPX4	
Motor protection rating	IP44		IP44		IP54		IP54	

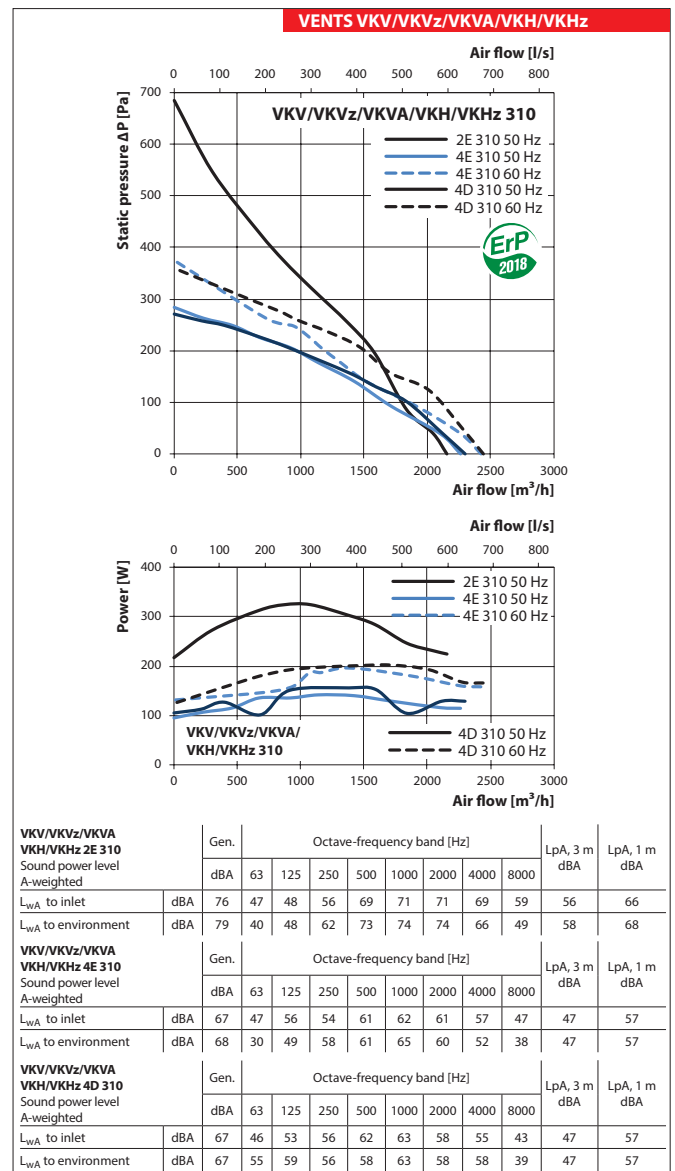
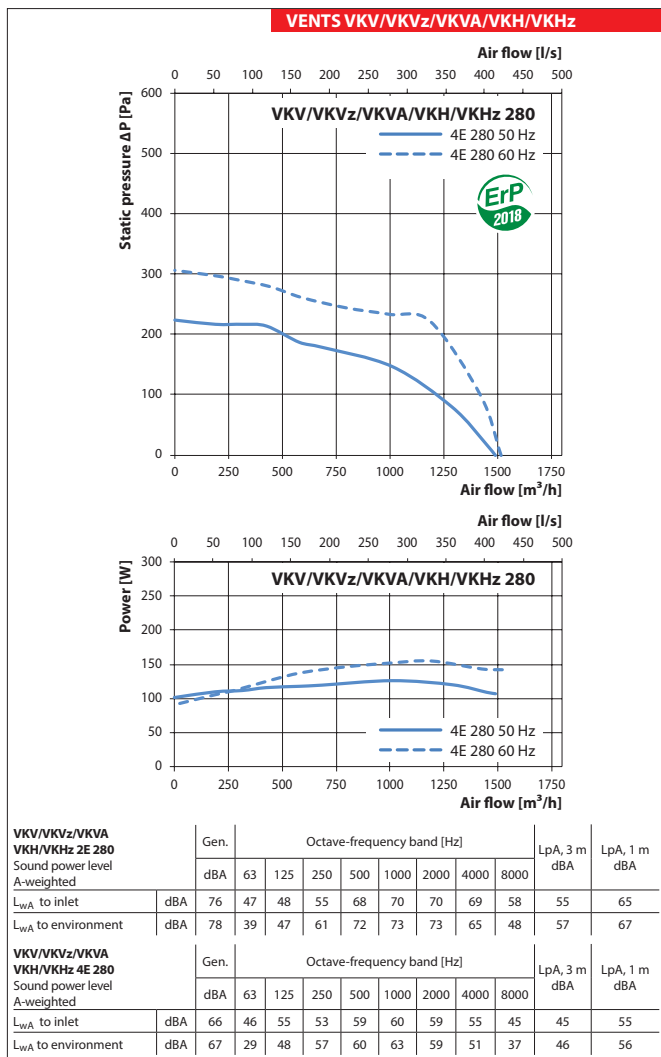

Technical data

	VKV/VKVz/VKVA/VKH/VKHz 4E 355		VKV/VKVz/VKVA/VKH/VKHz 4D 355		VKV/VKVz/VKH/VKHz 4E 400		VKV/VKVz/VKH/VKHz 6E 400		VKV/VKVz/VKH/VKHz 4D 400	
Voltage [V]	1~230		3~400		1~230		1~230		3~400	
Frequency [Hz]	50	60	50	60	50	50	60	50	50	
Power [W]	219	304	264	330	457	184	249	420		
Current [A]	0.96	1.33	0.58	0.64	2.00	0.89	1.10	0.99		
Max. air flow [m ³ /h]	2 480	2 976	3 290	3 540	3 950	2 740	3 289	3 950		
RPM [min ⁻¹]	1420	1580	1430	1650	1440	945	1071	1440		
Sound pressure level at 3 m [dBA]	51	52	52	53	55	47	49	55		
Transported air temperature [°C]	-25...+50		-30...+60		-30...+60		-30...+60		-30...+60	
Protection rating	IPX4		IPX4		IPX4		IPX4		IPX4	
Motor protection rating	IP54		IP54		IP54		IP54		IP54	

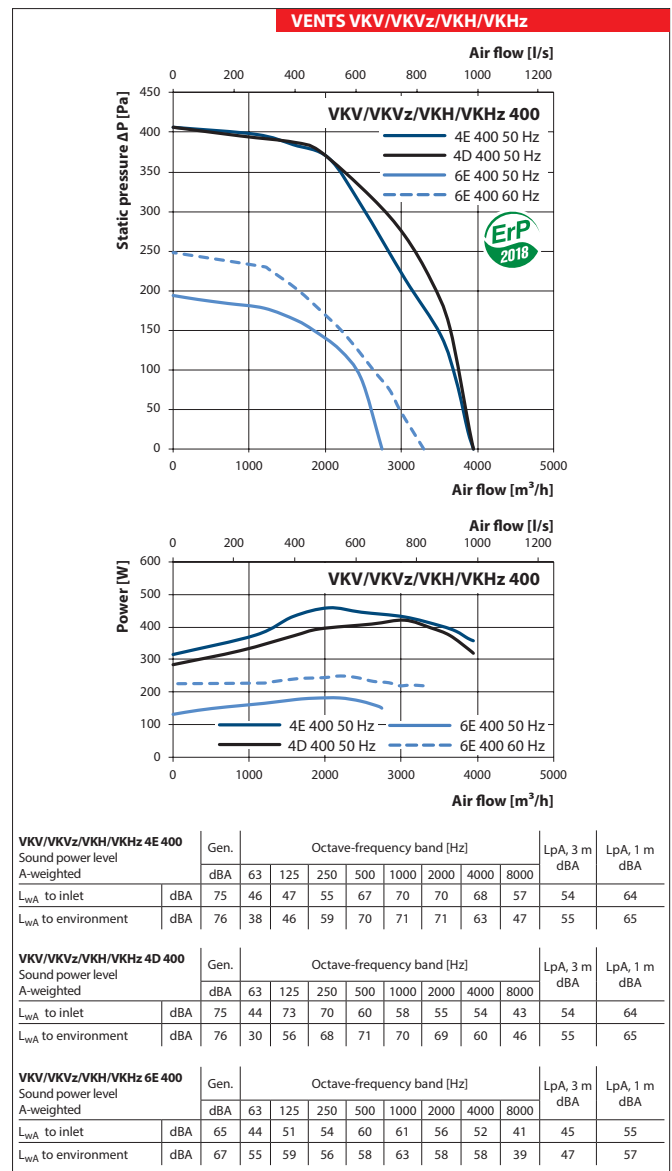
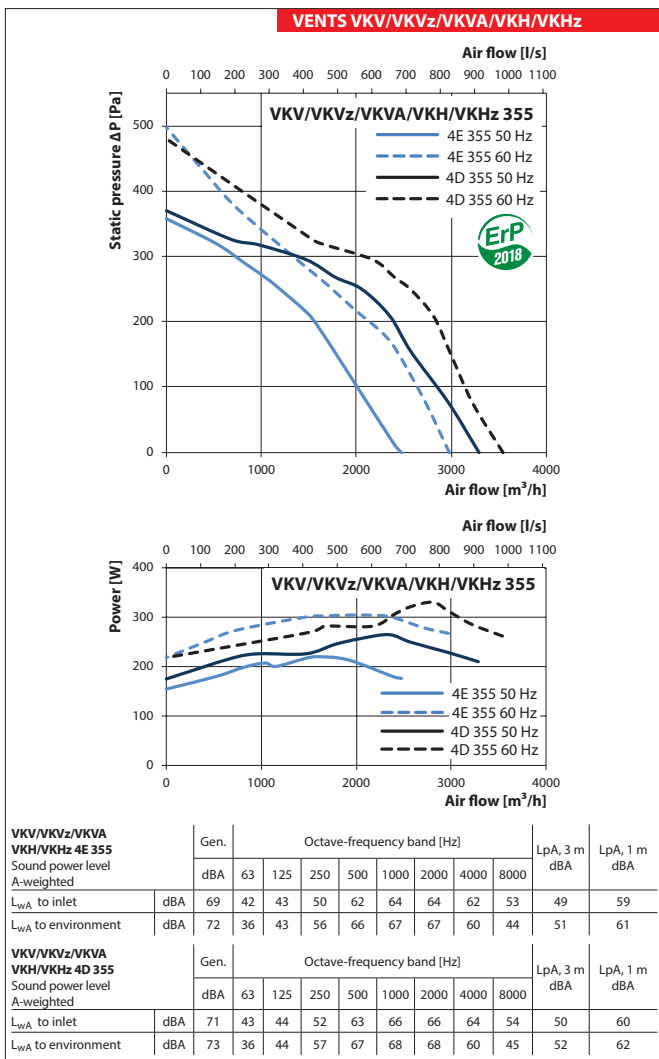

VENTS VKV/VKH FAN SERIES

Technical data

	VKV/VKVz/ VKH/VKHz 4E 450	VKV/VKVz/ VKH/VKHz 6E 450	VKV/VKVz/ VKH/VKHz 4D 450	VKV/VKVz/ VKH/VKHz 4D 500	VKV/VKVz/ VKH/VKHz 6E 500	VKV/VKVz/ VKH/VKHz 6D 500
Voltage [V]	1~230	1~230	3~400	3~400	1~230	3~400
Frequency [Hz]	50	50	50	50	50 60	50 60
Power [W]	749	268	755	1527	407 673	440 599
Current [A]	3.35	1.25	1.50	2.64	1.81 3.05	1.23 1.32
Max. air flow [m ³ /h]	6 180	4 380	5 920	8 435	5 680 6 532	6 000 6 122
RPM [min ⁻¹]	1400	940	1440	1460	970 1120	978 1125
Sound pressure level at 3 m [dBA]	58	50	57	62	52 54	52 54
Transported air temperature [°C]	-30...+60	-30...+60	-30...+50	-30...+50	-25...+60	-25...+60
Protection rating	IPX4	IPX4	IPX4	IPX4	IPX4	IPX4
Motor protection rating	IP54	IP54	IP54	IP54	IP54	IP54

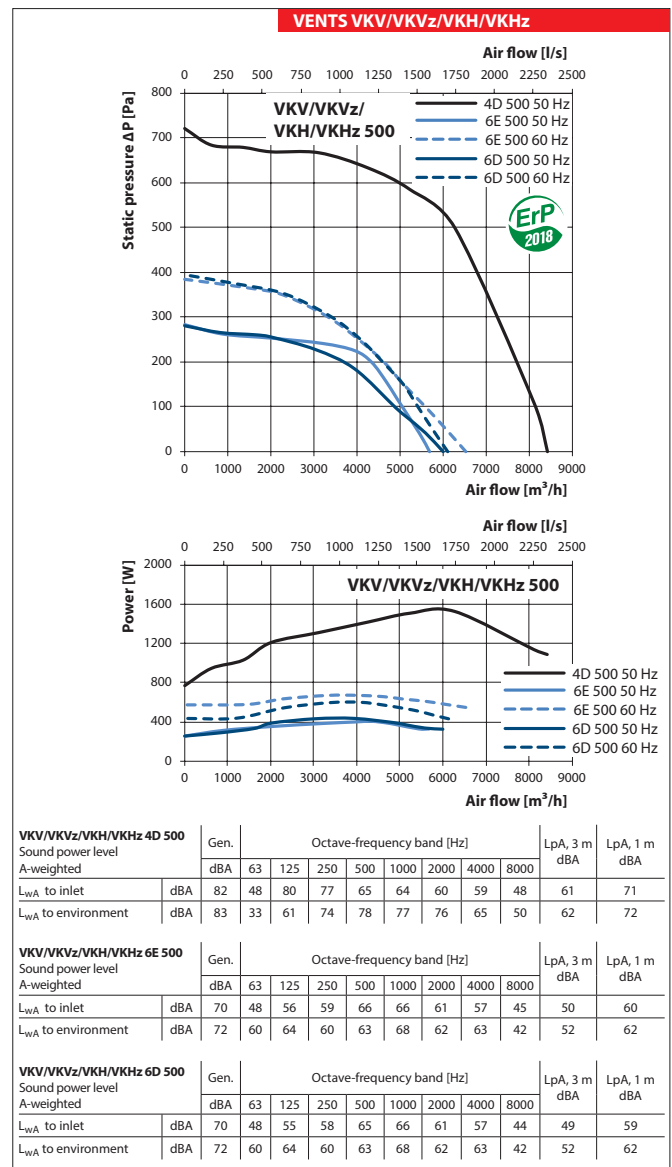
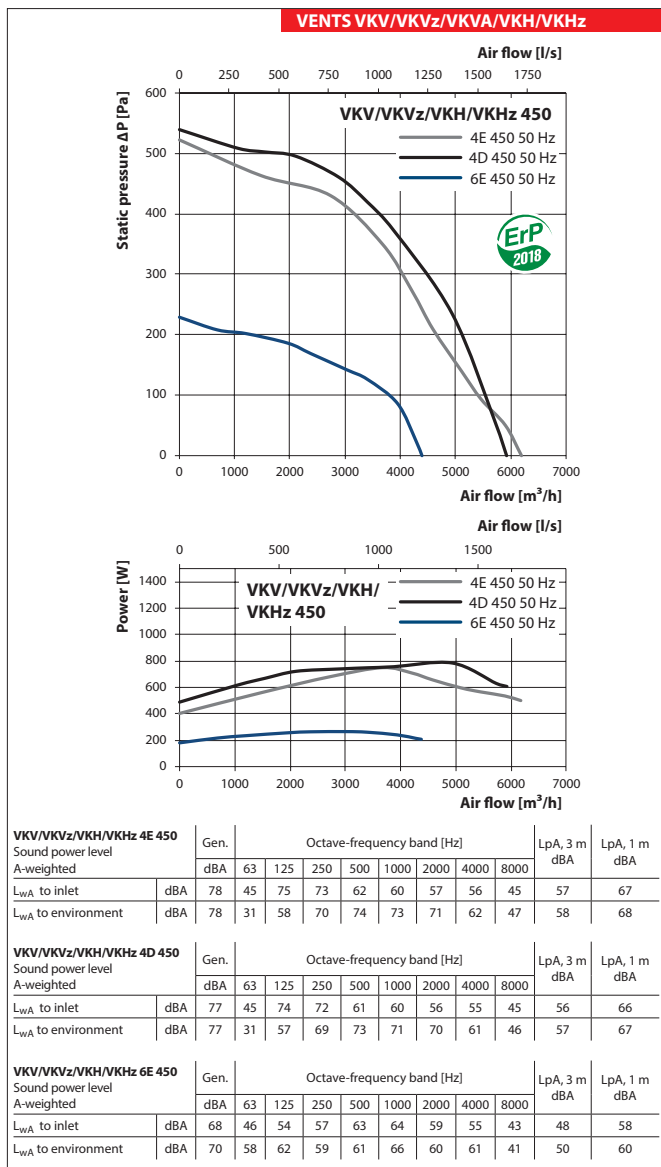

Technical data

	VKV/VKVz/ VKH/VKHz 4D 560	VKV/VKVz/ VKH/VKHz 6E 560	VKV/VKVz/ VKH/VKHz 6D 560	VKV/VKVz/ VKH/VKHz 6D 630
Voltage [V]	3~400	1~230	3~400	3~400
Frequency [Hz]	50	50	50	50
Power [W]	1970	613	696	1110
Current [A]	3.36	2.70	1.44	2.42
Max. air flow [m³/h]	13 560	9 560	9 630	12 640
RPM [min ⁻¹]	1400	930	970	957
Sound pressure level at 3 m [dBA]	66	58	58	64
Transported air temperature [°C]	-25...+50	-25...+50	-25...+50	-25...+50
Protection rating	IPX4	IPX4	IPX4	IPX4
Motor protection rating	IP54	IP54	IP54	IP54

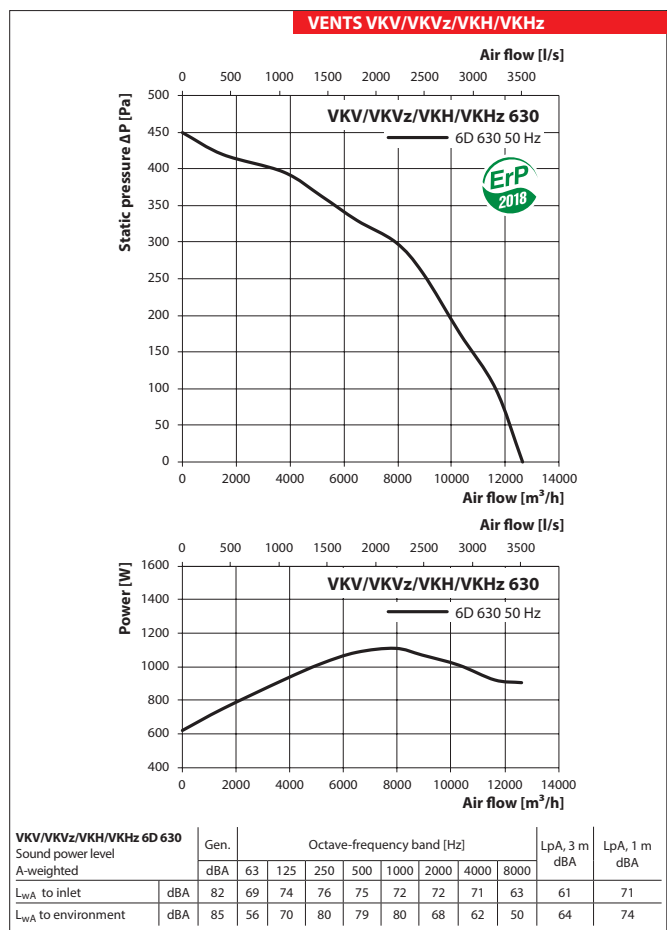
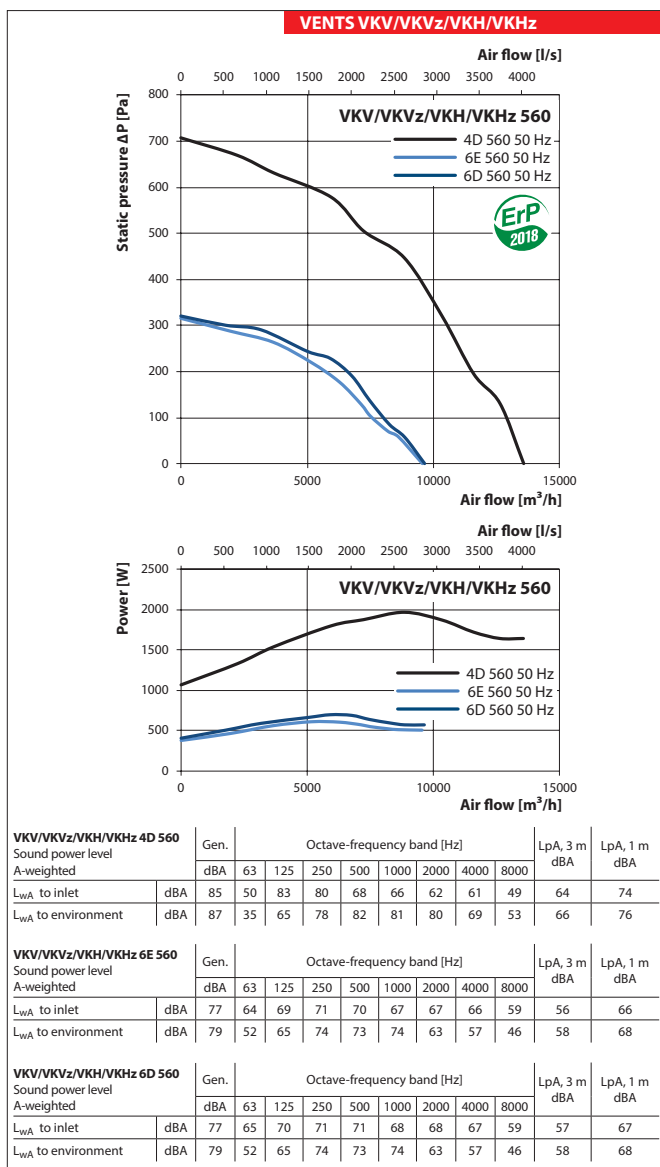

VENTS
VKV/VKH
FAN SERIES

CENTRIFUGAL ROOF FANS

Technical data

	VKV/VKVz/VKH/VKHz 6D 710
Voltage [V]	3~400
Frequency [Hz]	50
Power [W]	2583
Current [A]	4.87
Max. air flow [m ³ /h]	17 010
RPM [min ⁻¹]	945
Sound pressure level at 3 m [dBA]	67
Transported air temperature [°C]	-25...+70
Protection rating	IPX4
Motor protection rating	IP54

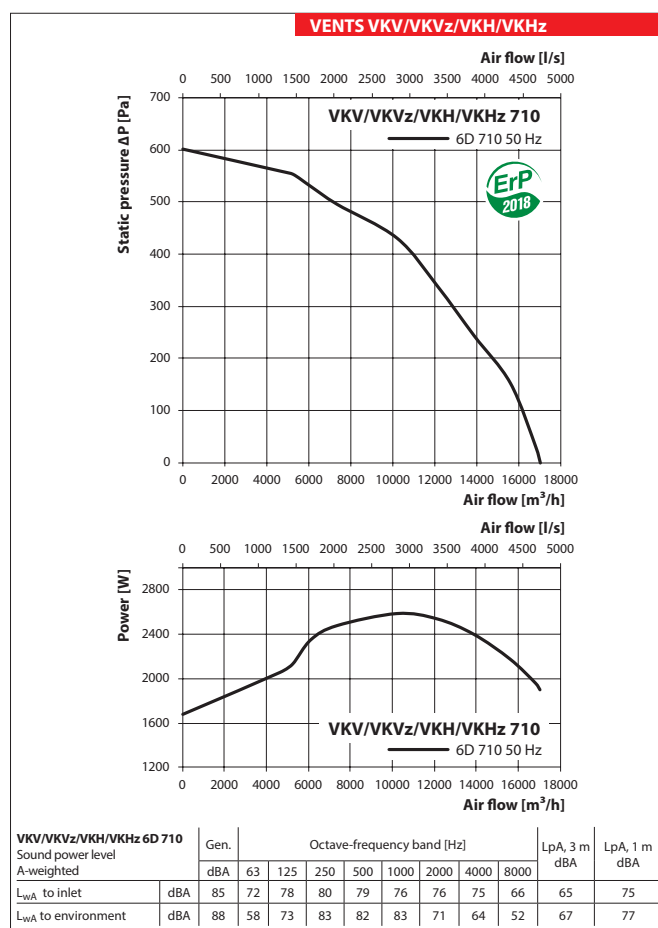

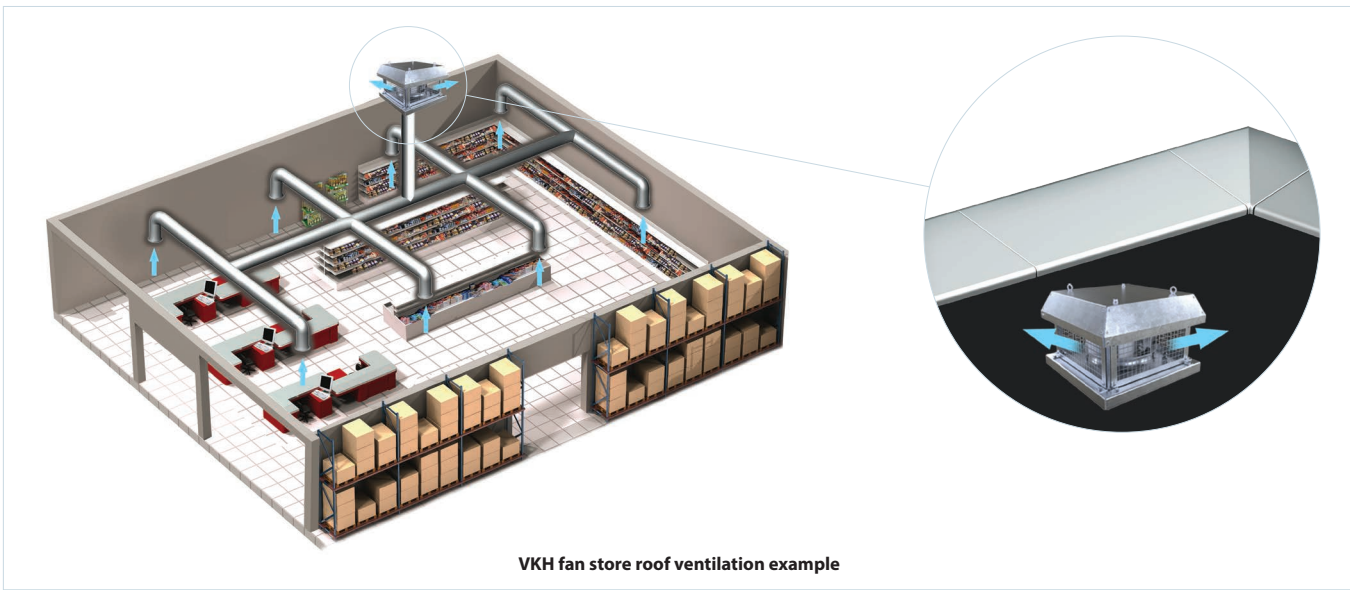

VKH fan store roof ventilation example

VENTS
VKV/VKH

FAN SERIES