

Bend 45°

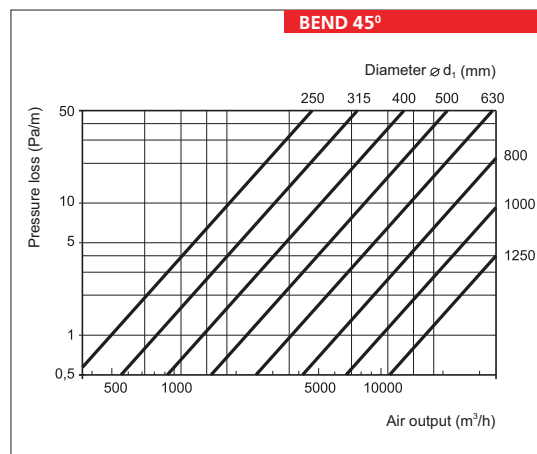
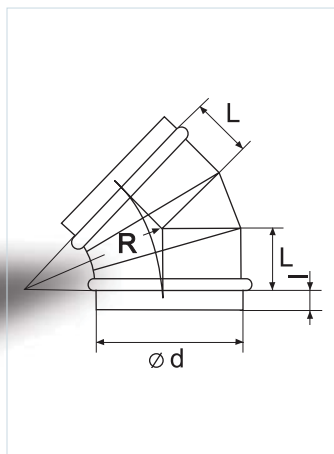

Type	Diameter (d), mm	Steel thickness (p), mm	Length (L), mm	l, mm	R, mm
Bend 45-125	125	0.50	52	50	125
Bend 45-140	140	0.50	56	50	140
Bend 45-150	150	0.50	62	50	150
Bend 45-160	160	0.50	66	50	160
Bend 45-180	180	0.50	76	50	180
Bend 45-200	200	0.50	83	50	200
Bend 45-224	224	0.50	93	50	224
Bend 45-250	250	0.50	104	50	250
Bend 45-280	280	0.50	116	50	280
Bend 45-315	315	0.50	130	50	315
Bend 45-355	355	0.50	142	60	355
Bend 45-400	400	0.70	162	60	400
Bend 45-450	450	0.70	186	60	450
Bend 45-500	500	0.70	204	80	500
Bend 45-560	560	0.70	232	80	560
Bend 45-600	600	0.70	249	80	600
Bend 45-630	630	0.70	261	80	630
Bend 45-710	710	0.70	294	80	710
Bend 45-800	800	0.70	331	80	800
Bend 45-900	900	1.00	373	100	900
Bend 45-1000	1000	1.00	414	100	1000
Bend 45-1120	1120	1.00	464	100	1120
Bend 45-1250	1250	1.00	518	100	1250