

Series
VENTS VKPI EC



Centrifugal fans for rectangular ducts.
Air flow up to **11190 m³/h**

■ **Application**

Supply and exhaust ventilation systems for commercial, office and other public or industrial premises requiring an economical solution, controlled ventilation system and low noise level.

EC motors applied in VKP fans reduce energy demand by 1.5 times and ensure high aerodynamic performance and low noise level. Such characteristics are of special importance for ventilation of banks, supermarkets, restaurants, hotels and other public facilities including swimming pool ventilation. The fans are compatible with 300x150–1000x500 mm rectangular ducts.

■ **Design**

Fan casing is made of galvanized steel and is heat- and sound-insulated with 50 mm mineral wool layer. All inner components are interconnected by means of rivets. The fan is equipped with 20 mm standard flanges.

■ **Motor**

The impellers with backward curved blades are powered with high efficient electronically commutated (EC) direct current motors with an external rotor. As of today, such motor type is the most advanced solution for energy saving. EC motors are featured by high performance and the optimal control over the whole range of fan speeds. Premium efficiency reaching up to 90 % is an absolute advantage of electronically commutated motors.

■ **Integrated functions and control**

The fan is controlled with an external control signal 0-10 V (air flow as a function of temperature level, pressure and smoke conditions etc). If the control value factor changes, the EC motor changes its speed and the fan boosts as much air flow to the ventilation system as required. Maximum speed of the fan does not depend on the current frequency and it can operate at 50 or 60 Hz mains supply.

Fan overall dimensions

Type	Dimensions [mm]									Weight [kg]	
	B	B1	B3	H	H1	H3	L	F	K		
VKPI 300 x 150 M1 EC	300	320	364	150	170	271	370				10.3
VKPI 300 x 150 L1 EC	300	320	364	150	170	271	370				10.3
VKPI 400 x 200 M1 EC	400	420	464	200	220	322	460				15.1
VKPI 400 x 200 L1 EC	400	420	464	200	220	322	460				16.8
VKPI 500 x 250 M1 EC	500	520	564	250	270	373	560				25.5
VKPI 500 x 250 L1 EC	500	520	564	250	270	373	560				27.7
VKPI 500 x 300 L1 EC	500	520	564	300	320	424	560				29.0
VKPI 600 x 300 M1 EC	600	620	783	300	320	574	752	755	450		52.9
VKPI 600 x 350 M1 EC	600	620	783	350	370	664	752	755	450		56.6
VKPI 600 x 350 L3 EC	600	620	783	350	370	664	752	750	450		59.3
VKPI 700 x 400 M1 EC	700	720	883	400	420	714	882	855	742		82.6
VKPI 700 x 400 L3 EC	700	720	883	400	420	714	882	855	742		83.4
VKPI 800 x 500 M3 EC	800	820	983	500	520	814	937	955	797		108.4
VKPI 800 x 500 L3 EC	800	820	983	500	520	814	937	955	797		99.8
VKPI 900 x 500 L3 EC	900	920	1083	500	520	814	1052	1055	850		120.0
VKPI 1000 x 500 L3 EC	1000	1020	1183	500	520	814	1052	1155	850		130.0

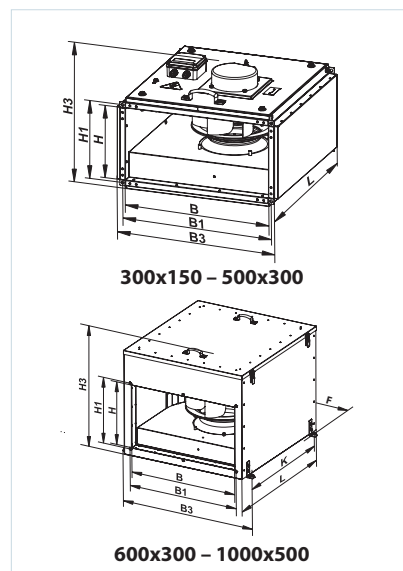

Designation key

Series	Rectangular air duct diameter (WxH) [mm]	Motor modification	Phase	Motor
VKP – centrifugal fan VKPI – centrifugal fan in sound-insulated casing	300x150; 400x200; 500x250; 500x300; 600x300; 600x350; 700x400; 800x500; 900x500; 1000x500	L : medium pressure motor M : high pressure motor	1 : single phase 3 : three phase	EC : synchronous electronically commutated motor

Accessories



■ Mounting

The fans are mounted into the rectangular ducts and require no special fixing in sizes 300x150–500x300. For large size fans and in case of connection through the flexible connectors, the fan is fixed to a building by means of supports, suspension brackets or fixation brackets. The fans can be mounted in any

position with respect to the airflow direction which is indicated with a pointer on the casing. Access for the fan maintenance shall be provided. The casing is provided with the removable access door for inspection and maintenance purposes.

Technical data

	VKPI 300x150 M1 EC	VKPI 300x150 L1 EC
Voltage [V/50 (60) Hz]	1~230	1~230
Power [W]	97	101
Current [A]	0.73	0.80
Maximum air flow [m³/h]	565	665
RPM [min ⁻¹]	3300	3500
Noise level at 3 m [dBA]	29	30
Transported air temperature [°C]	-25...+50	
SEC class	B	
Motor protection	IP55	IP54
Protection rating	IPX4	

VENTS VKPI EC
FAN SERIES

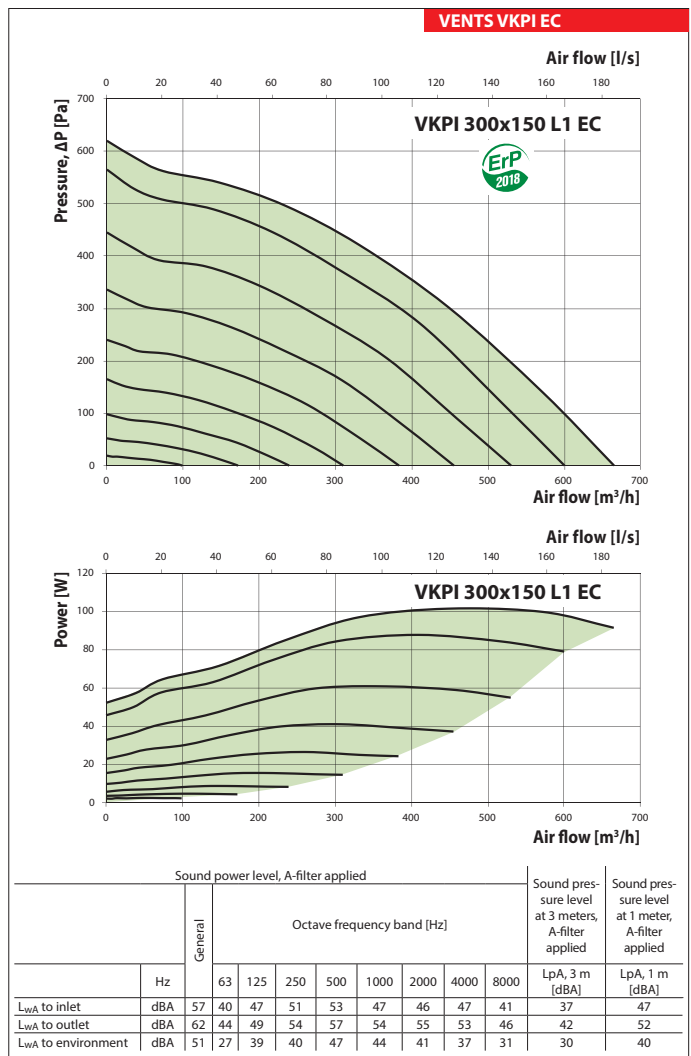
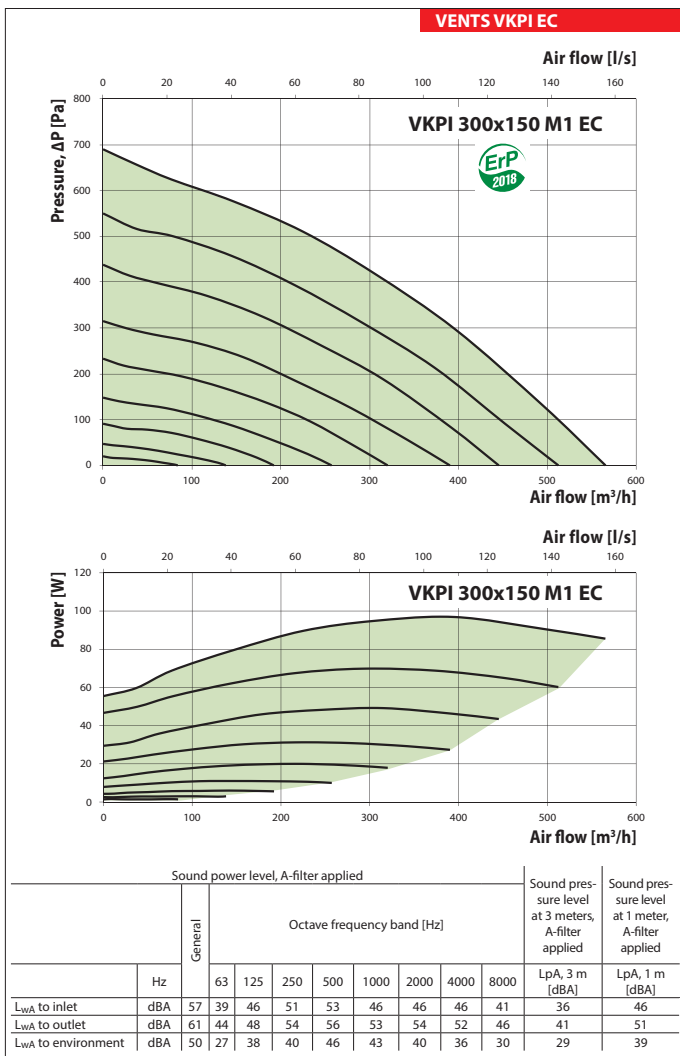

Technical data

	VKPI 400x200 M1 EC	VKPI 400x200 L1 EC
Voltage [V/50 (60) Hz]	1~230	1~230
Power [W]	91	192
Current [A]	0.69	1.43
Maximum air flow [m ³ /h]	810	1190
RPM [min ⁻¹]	2470	3010
Noise level at 3 m [dBA]	33	30
Transported air temperature [°C]	-25...+50	
SEC class	B	-
Motor protection	IP55	IP54
Protection rating	IPX4	

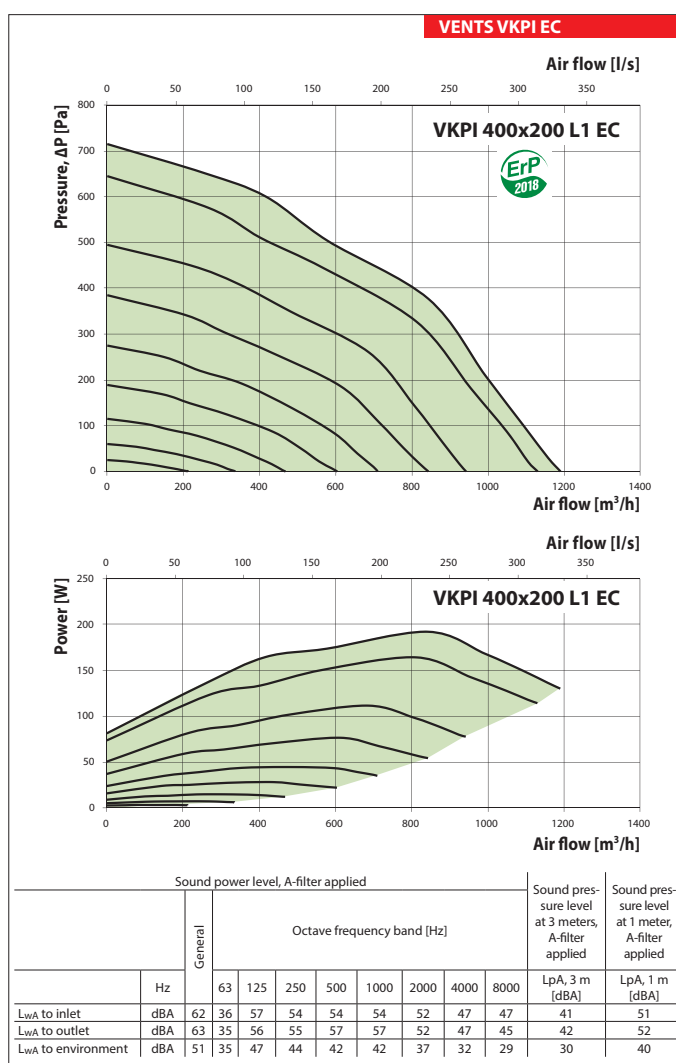
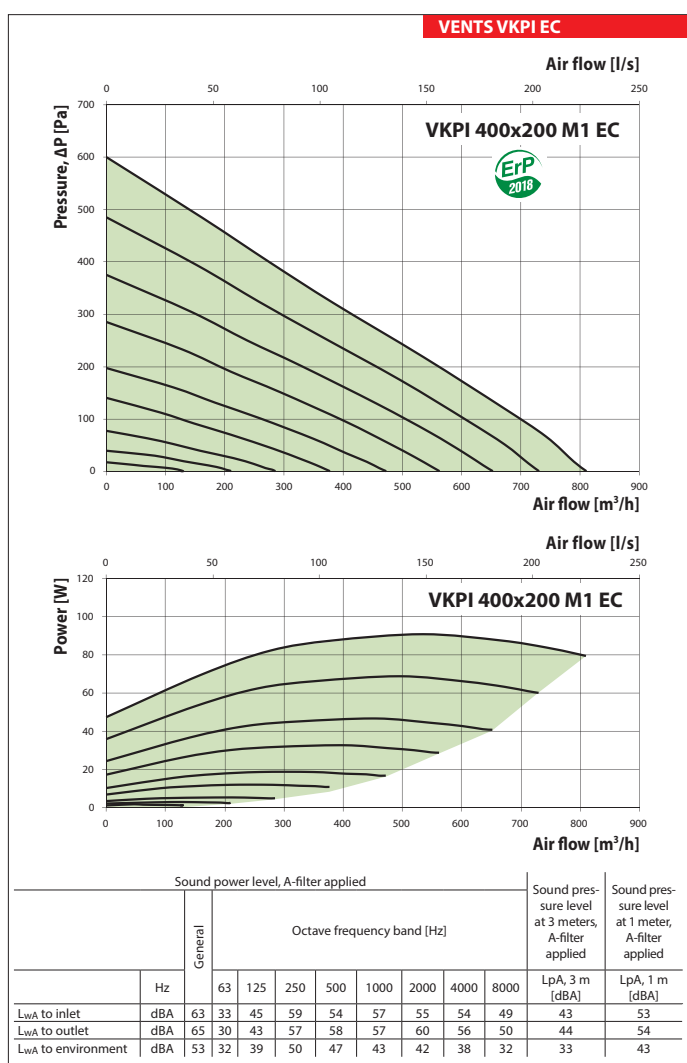

Technical data

	VKPI 500x250 M1 EC	VKPI 500x250 L1 EC
Voltage [V/50 (60) Hz]	1~230	1~230
Power [W]	252	555
Current [A]	1.85	4,10
Maximum air flow [m³/h]	1590	2480
RPM [min ⁻¹]	2500	3100
Noise level at 3 m [dBA]	34	51
Transported air temperature [°C]	-25...+50	
Motor protection	IP54	
Protection rating	IPX4	

VENTS
FAN SERIES
VKPI EC

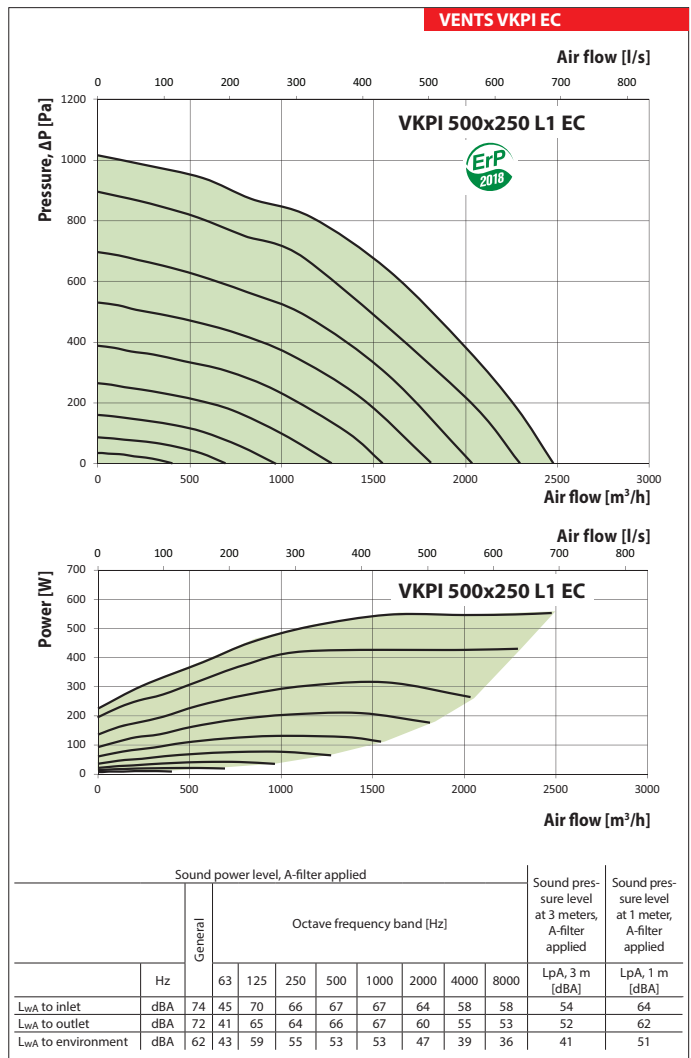
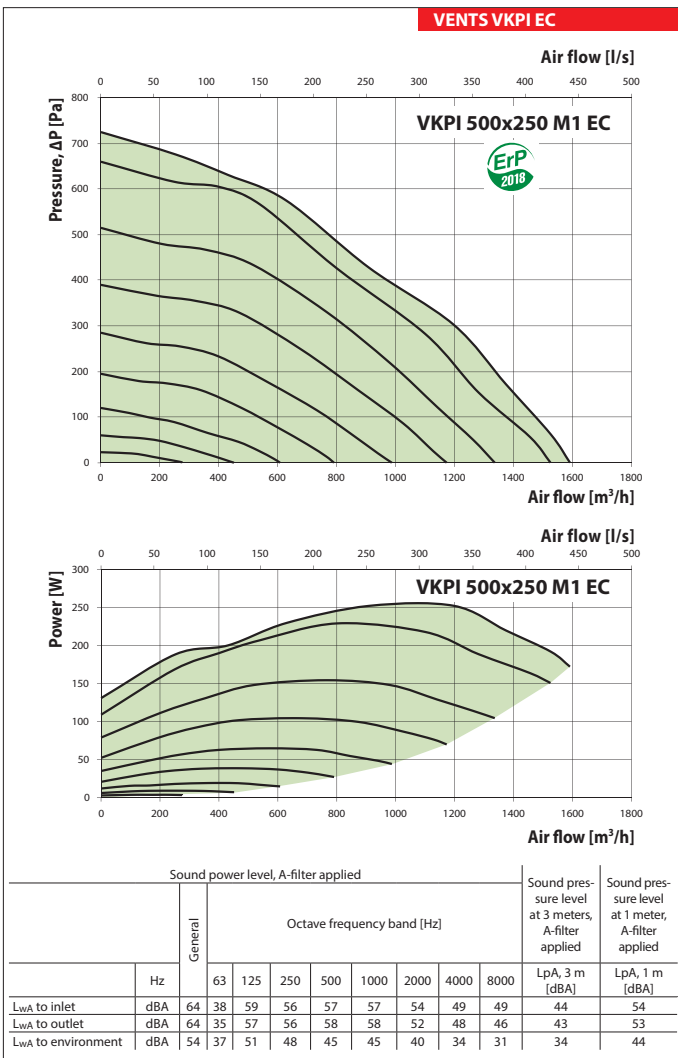

Technical data

	VKPI 500x300 L1 EC	VKPI 600x300 M1 EC
Voltage [V/50 (60) Hz]	1~230	1~230
Power [W]	553	326
Current [A]	4.20	2.45
Maximum air flow [m ³ /h]	2700	2545
RPM [min ⁻¹]	3100	2000
Noise level at 3 m [dBA]	43	34
Transported air temperature [°C]	-25...+50	
Motor protection	IP54	
Protection rating	IPX4	

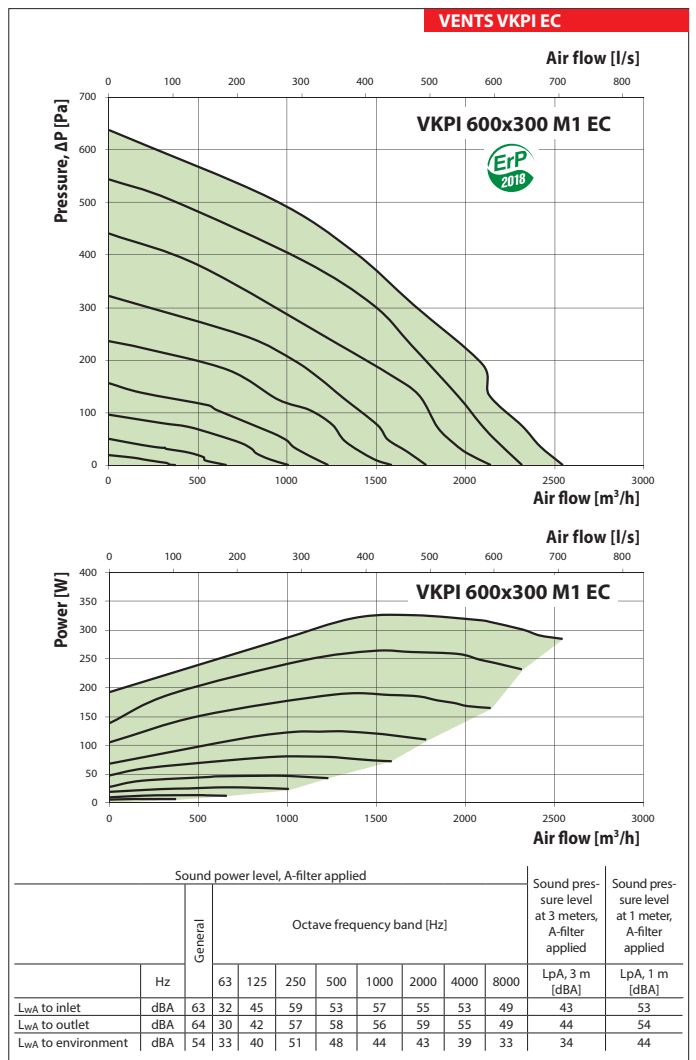
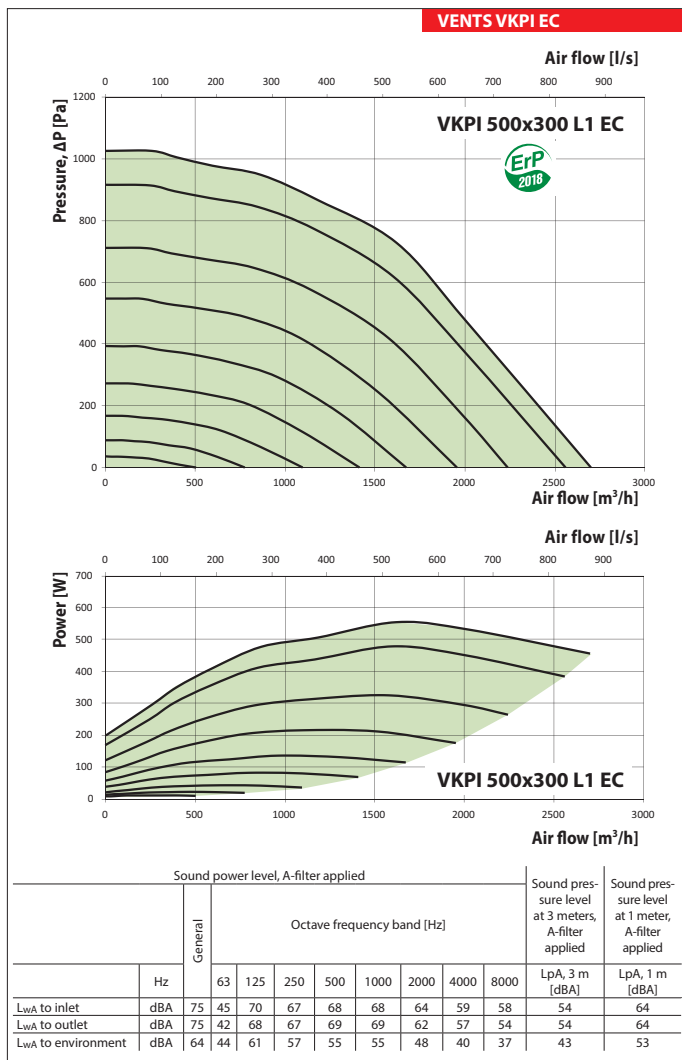

Technical data

	VKPI 600x350 M1 EC	VKPI 600x350 L3 EC
Voltage [V/50 (60) Hz]	1~230	3~400
Power [W]	361	1308
Current [A]	2.62	2.35
Maximum air flow [m³/h]	2815	4290
RPM [min⁻¹]	2000	3160
Noise level at 3 m [dBA]	38	40
Transported air temperature [°C]	-25...+50	
Motor protection	IP54	
Protection rating	IPX4	

VENTS
FAN SERIES
VKPI EC

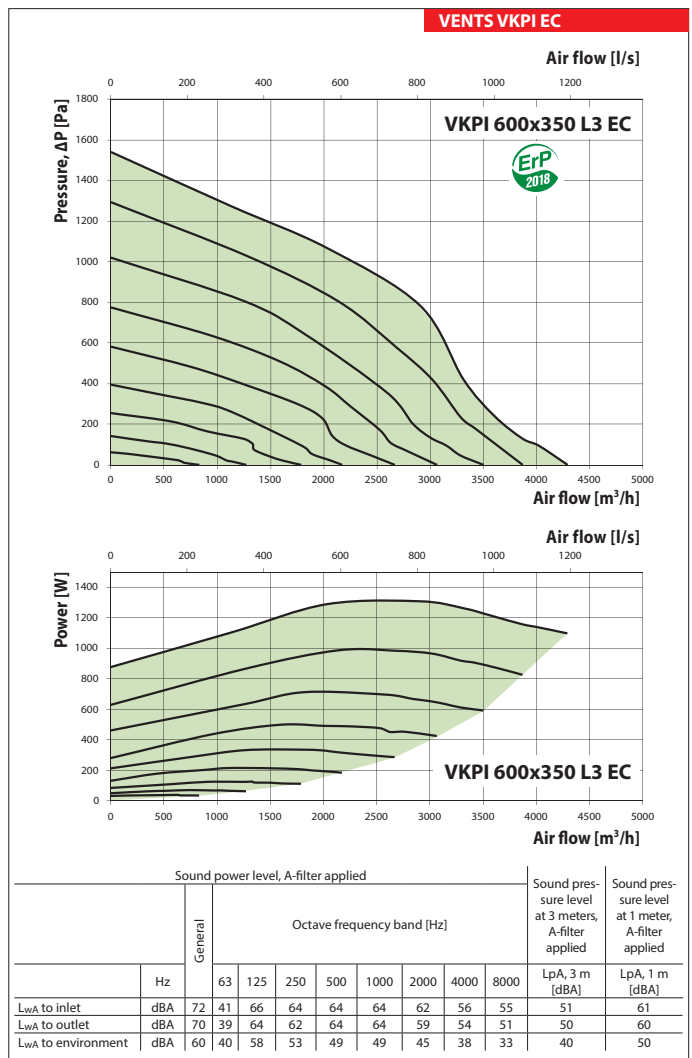
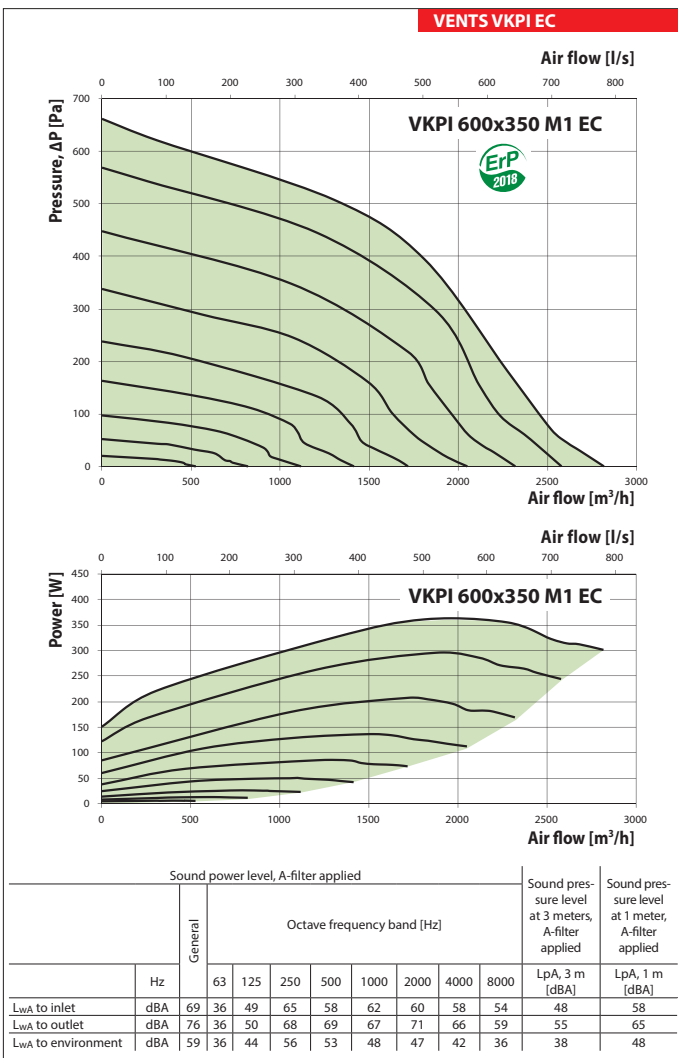

Technical data

	VKPI 700x400 M1 EC	VKPI 700x400 L3 EC
Voltage [V/50 (60) Hz]	1~230	3~400
Power [W]	795	2748
Current [A]	3.48	2.80
Maximum air flow [m ³ /h]	5710	6810
RPM [min ⁻¹]	1400	2530
Noise level at 3 m [dBA]	37	43
Transported air temperature [°C]	-25...+50	
Motor protection	IP54	
Protection rating	IPX4	

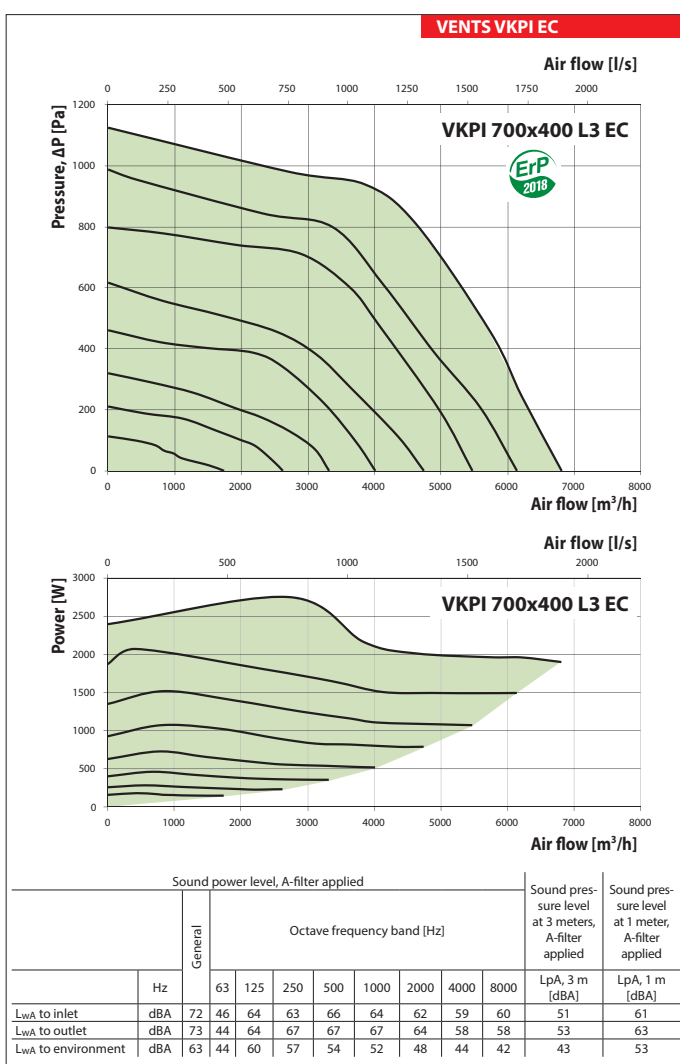
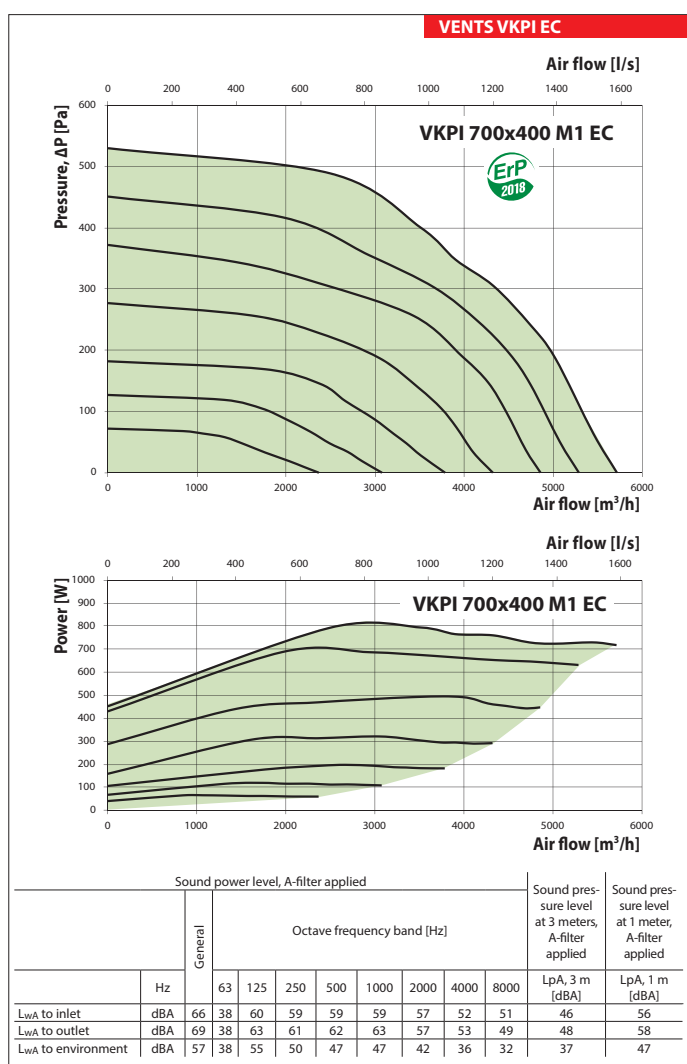

Technical data

	VKPI 800x500 M3 EC	VKPI 800x500 L3 EC
Voltage [V/50 (60) Hz]	3~400	3~400
Power [W]	2025	2925
Current [A]	2.01	3.05
Maximum air flow [m³/h]	8395	8535
RPM [min ⁻¹]	1470	2400
Noise level at 3 m [dBA]	43	42
Transported air temperature [°C]	-25...+50	
Motor protection	IP54	
Protection rating	IPX4	

VENTS
FAN SERIES
VKPI EC

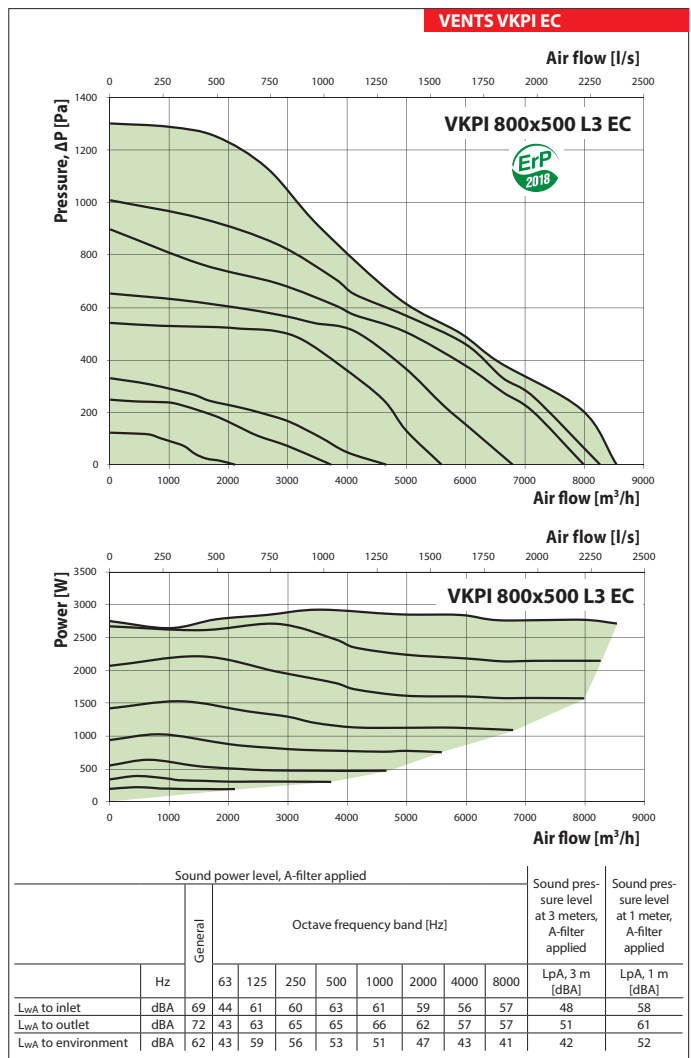
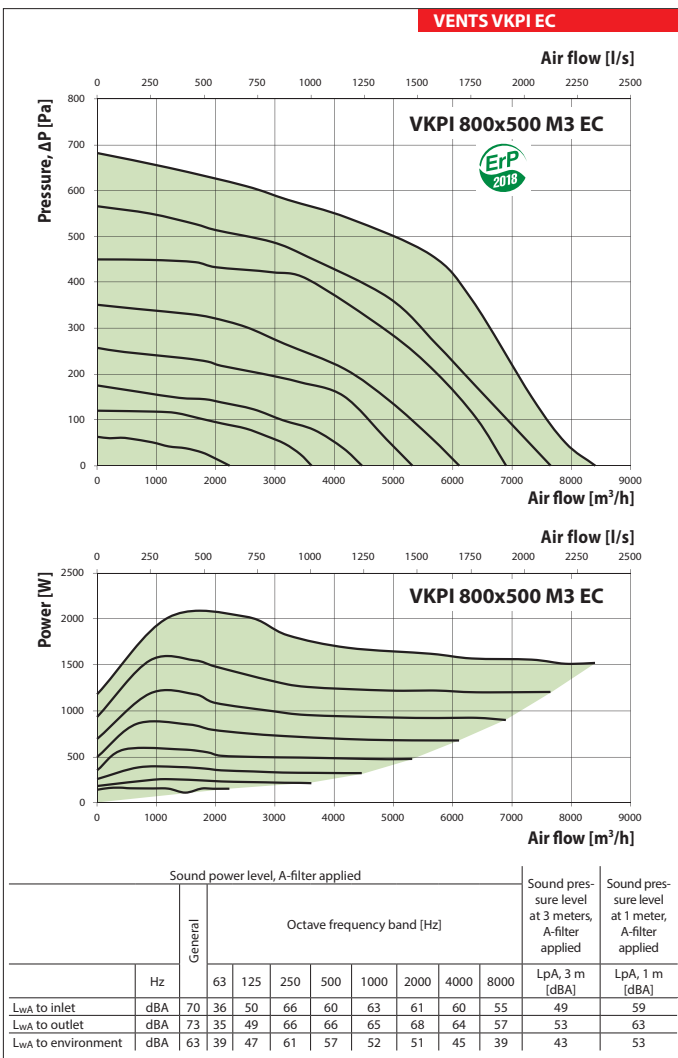

Technical data

	VKPI 900x500 L3 EC	VKPI 1000x500 L3 EC
Voltage [V/50 (60) Hz]	3~400	3~400
Power [W]	3429	3429
Current [A]	5.00	5.00
Maximum air flow [m ³ /h]	11190	11190
RPM [min ⁻¹]	1800	1800
Noise level at 3 m [dBA]	47	47
Transported air temperature [°C]	-25...+50	
Motor protection	IP54	
Protection rating	IPX4	

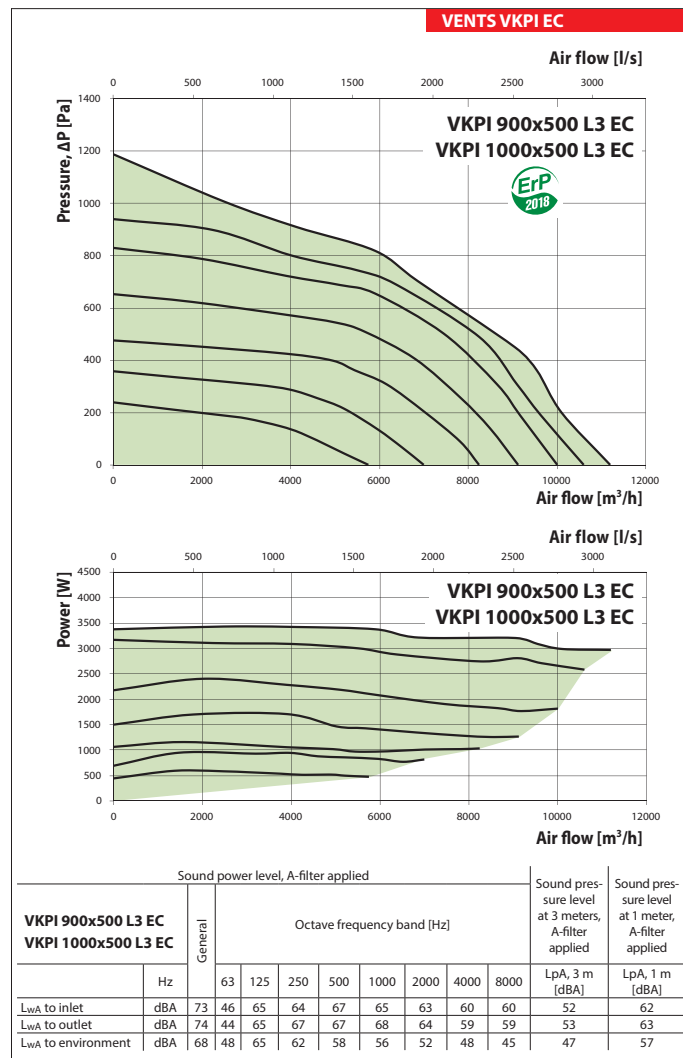

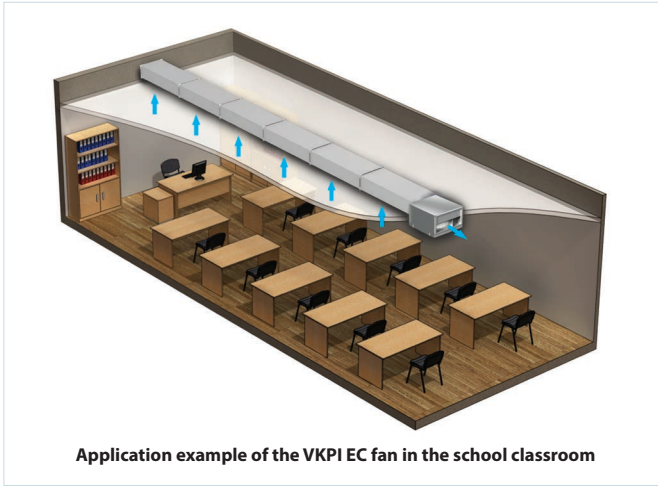

Application example of the VKPI EC fan in the school classroom

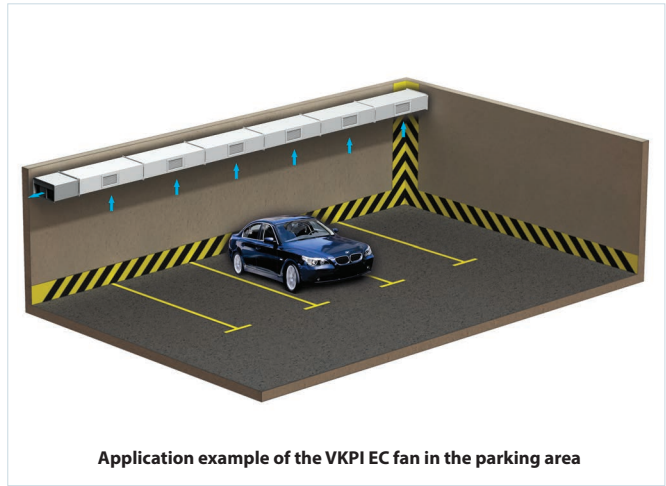

Application example of the VKPI EC fan in the parking area

VENTS
FAN SERIES
VKPI EC