

VENTS Quietline Series

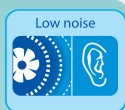

Brand new low-noise axial inline fans, for exhaust or supply ventilation with superior capacity up to 375 m³/h

Applications

- Innovative stylish extract or supply fans for enhanced comfort level.
- Continuous or periodic ventilation of bathroom, showers, kitchens and other utility spaces.
- Maximum air flow combined with low noise level ensures an ideal room microclimate.
- Exhaust or supply ventilation depending on fan installation in the system.
- Designed for plastic (flexible) ducts.
- Transportation of low and medium air flow volumes for small distances at low air resistance in the ventilation system.
- Compatible with Ø 100, 125 and 150 mm air ducts.

Motor

- Reliable ball bearing motor with low energy demand from 4.5 W.
- VENTS Quietline models are equipped with a single-phase single or two speed motor (Quietline Duo and Quietline Extra modifications).
- The integrated thermal overheating protection prevents motor overload.
- The motor rests on rubber anti-vibration connectors to ensure low-noise operation of the fan (except for VENTS Quietline 150 Q).

Modifications and Options



Quietline Extra: modification with a two speed high-powered motor.



Quietline Duo: modification with a reliable single-phase two speed motor.



Quietline Q: modification with a low-speed motor for quiet operation.



Quietline 12: modification with a low voltage 12V AC motor.



Quietline K: modification with a backdraft damper for back flow prevention.



Quietline T: modification with a regulated timer with the operating time adjustable from 2 to 30 minutes.

Quietline R: modification with a power cord and IEC C14 electric plug.

Quietline-k: modification with a fixing bracket for flat surface mounting.

Operation modes of fans with timer

Operation modes for T modifications of VENTS Quietline 100, VENTS Quietline 125, VENTS Quietline 150 and VENTS Quietline 150 Extra models are selected by setting the DIP switch in required position.

Mode 1

- The fan is turned off by default. The fan starts operating at the low speed when the switch is closed.

Mode 2

- The fan is turned off by default. The fan starts operating at the high speed when the switch is closed.

Mode 3 (two-speed mode)

- The fan operates at the low speed by default. The fan switches to the high speed when the switch is closed.

Mode 4 (automatic interval mode)

- The fan operates at the low speed by default. The fan switches to the high speed each set time period (adjustable from 1 to 15 hours) and operates up to 30 min to ventilate the premise with maximum capacity. After that the fan models back to the continuous operation at low speed.

Control

Manual speed control:

- The fan is controlled by a room light switch. It is not included in the delivery package.
- Speed control is performed with RS-1-300 or RS-1-400 thyristor speed controller (applicable for the models without timer). Optionally, speed control for VENTS Quietline 100 Duo, VENTS Quietline 125 Duo, VENTS Quietline 150 Duo, VENTS Quietline 150 Extra may be performed with P2-1-300 speed switch (for details, see Electrical Accessories).

Automatic speed control:

- With **BU-1-60** electronic control unit (for details, see Electrical Accessories). Available upon separate order.
- With timer T (integrated turn-off delay timer keeps the fan operating 2 up to 30 minutes after turning the fan off).

Mounting features

- The fan is mounted into a matching duct size. Fastening with clamps in case of flexible duct connection.
- The mounting bracket enables fan installation on both horizontal and vertical flat surfaces (**Quietline-k** model).
- Serial mounting of two fans boosts the operation pressure.
- For 12 V low-voltage motor fan connection to 220 V / 50 Hz power mains use the step-down transformer TRF 220/12-25 (available upon separate order).

Accessories



■ Design

- The casing and the impeller are made of high-quality durable plastic.
- The exhaust spigot is fitted with specially designed air flow rectifiers to reduce air turbulence, noise level and increase air pressure.

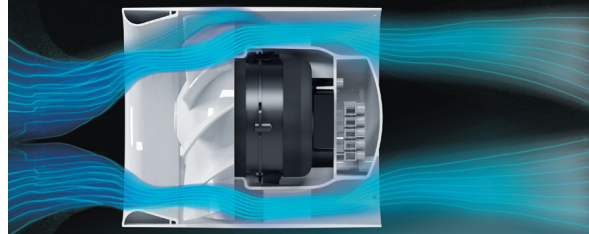

- The impeller design enhances fan efficiency and ensures low-noise operation of the fan.
- Ingress protection rating IP X4.

■ Overall dimensions, mm

Model	L	ø D	k
VENTS Quietline 100	137.5	99	-
VENTS Quietline-k 100	137.5	99	54
VENTS Quietline 125	161.5	125	-
VENTS Quietline-k 125	161.5	125	53.5
VENTS Quietline 150	182	150	-
VENTS Quietline-k 150	182	150	54

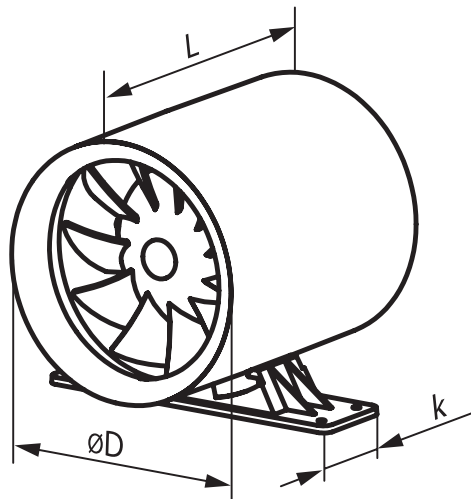

Aerodynamic characteristics

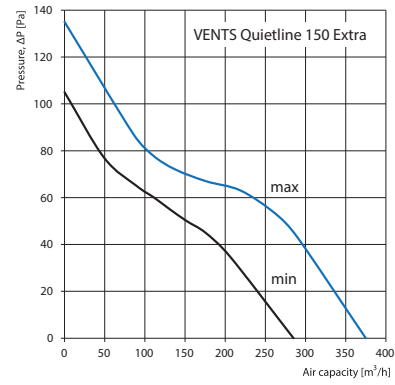
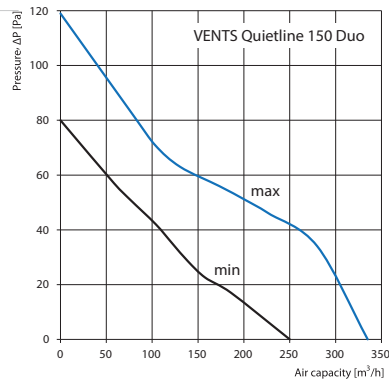
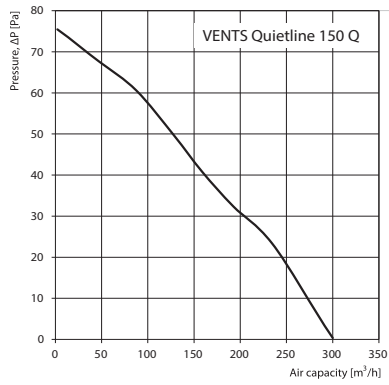
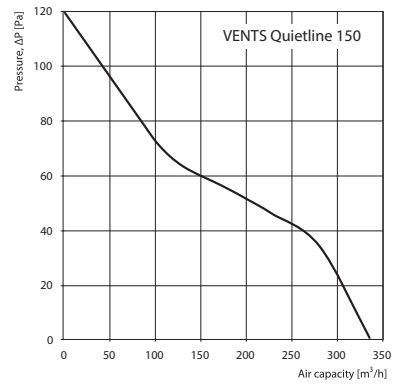
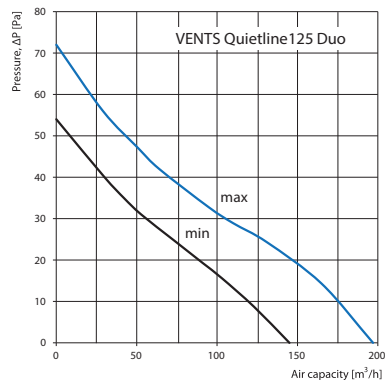
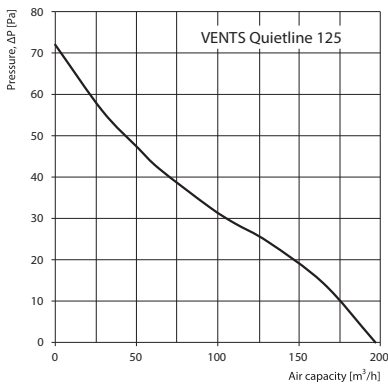
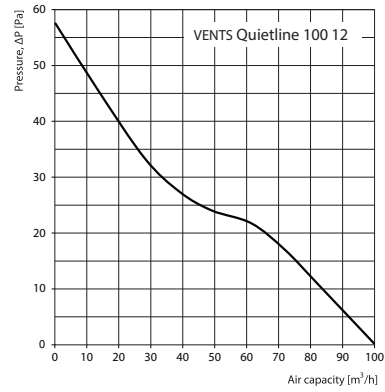
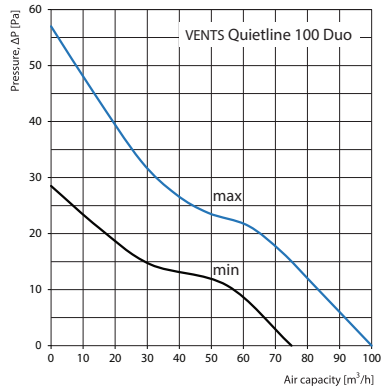
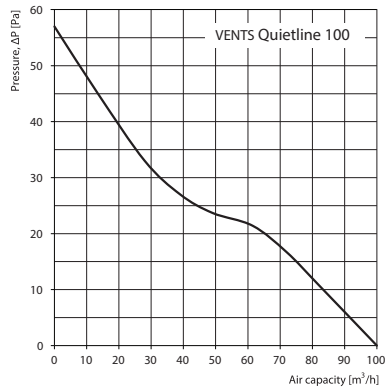

■ Technical data

Model	Speed	Frequency [Hz]	Voltage [V]	Power consumption [W]	Current [A]	r.p.m.	Maximum air capacity [m³/h]	Sound Pressure Level at 3 m [dB(A)]	Weight [kg]	
VENTS Quietline 100	-	50	220-240	7.5	0.049	2100	100	25	0.61	
VENTS Quietline 100 [220-240 W/60 Hz]	-	60								
VENTS Quietline 100 Duo	min.	50	220-240	4.5	0.029	1650	75	22		
	max.			7.5	0.049	2100	100	25		
VENTS Quietline 100 Duo [220-240 W/60 Hz]	min.	60	220-240	4.5	0.029	1650	75	22		
	max.			7.5	0.049	2100	100	25		
VENTS Quietline 100 12	-	50	12	7.5	0.99	2100	100	25		
VENTS Quietline 100 12 [12 W/60 Hz]	-	60								
Vents Quietline 125	-	50	220-240	13	0.085	2250	197	32		0.75
Vents Quietline 125 [220-240 W/60 Hz]	-	60								
Vents Quietline 125 Duo	min.	50	220-240	10	0.065	1950	145	29		
	max.			13	0.085	2250	197	32		
Vents Quietline 125 Duo [220-240 W/60 Hz]	min.	60	220-240	10	0.065	1950	145	29		
	max.			13	0.085	2250	197	32		
VENTS Quietline 150	-	50	220-240	22	0.095	2250	335	39		
VENTS Quietline 150 [220-240 W/60 Hz]	-	60								
VENTS Quietline 150 Q	-	50	220-240	26	0.085	1900	305	37	1.3	
VENTS Quietline 150 Q [220-240 W/60 Hz]	-	60								
VENTS Quietline 150 Duo	min.	50/60	220-240	19	0.087	1950	250	36		
	max.			22	0.095	2250	335	39		
VENTS Quietline 150 Extra	min.	50/60	220-240	22	0.103	2300	285	36		
	max.			25	0.109	2600	375	41		

■ Mounting examples

