



AXIAL FAN  
User's manual

[www.ventilation-system.com](http://www.ventilation-system.com)



100 Style Eco



## CONTENTS

Delivery set.....	6
Brief description .....	6
Operation guidelines .....	6
Designation key.....	7
Installation and set-up.....	7
Connection to power mains .....	8
Fan control.....	9
Maintenance.....	22
Storage and transportation regulations.....	22
Manufacturer's warranty .....	23

This user's manual is a main operating document, intended for technical, maintenance, and operating staff.

The manual contains information about the purpose, technical details, operating principle, design, and installation of the 100 Style Eco unit and all of its modifications.

Technical and maintenance staff must have theoretical and practical training in the field of ventilation systems and should be able to work in accordance with workplace safety rules as well as construction norms and standards applicable in the territory of the country.

The information in this user's manual was correct at the time of the document's preparation.

The Company reserves the right to modify the technical characteristics, design, or configuration of its products at any time in order to incorporate the latest technological developments.

No part of this publication may be reproduced, stored in a retrieval system, or transmitted, in any form or by any means in any information search system or translated into any language in any form without the prior written permission of the Company.



**READ THE USER'S MANUAL CAREFULLY BEFORE PROCEEDING WITH INSTALLATION WORKS.  
COMPLIANCE WITH THE MANUAL REQUIREMENTS ENSURES RELIABLE OPERATION AND LONG  
SERVICE LIFE OF THE UNIT.  
KEEP THE USER'S MANUAL AVAILABLE AS LONG AS YOU USE THE UNIT. YOU MAY NEED TO RE-  
READ THE INFORMATION ON THE PRODUCT SERVICING.**



**FOLLOW THE USER'S MANUAL REQUIREMENTS TO ENSURE DURABLE AND TROUBLE-FREE OPERATION OF THE UNIT.**

Disconnect the unit from power supply prior to any connection, servicing, maintenance, and repair operations.

**Only qualified electricians with a work permit for electrical units up to 1000 V are allowed for installation and maintenance. The present user's manual should be carefully read before beginning works.**

- Single-phase power mains must comply with the acting local electrical norms and standards.
- Fixed electrical wiring must be equipped with an automatic circuit breaker.
- The unit must be connected to power mains through a QF automatic circuit breaker integrated into the fixed wiring system. The gap between the circuit breaker contacts on all poles must be not less than 3 mm. Check the unit for any visible damages of the impeller and the casing before starting installation. The casing internals must be free of any foreign objects that can damage the impeller blades.
- While mounting the unit, avoid compression of the casing! Deformation of the casing may result in the motor jam and noisy operation. Misuse of the unit and any unauthorised modifications are not allowed.
- Take steps to prevent ingress of smoke, carbon monoxide, and other combustion products into the room through open chimney flues or other fire-protection devices. Sufficient air supply must be provided for proper combustion and exhaust of gases through the chimney of fuel burning

equipment to prevent back drafting. Transported air must not contain any dust or other solid impurities, sticky substances, or fibrous materials.

- Do not use the unit in a hazardous or explosive environment containing spirits, gasoline, insecticides, etc.
- Do not close or block the intake or extract vents in order to ensure the efficient air flow.
- Do not sit on the unit and do not put objects on it.
- The unit is allowed to be used by children aged from 8 years old and above and persons with reduced physical, sensory, or mental capabilities or no experience and knowledge provided that they have been given supervision or instruction regarding safe use of the unit and understand the risks involved.
- Do not allow children to play with the unit.



**THE PRODUCT MUST BE DISPOSED SEPARATELY AT THE END OF ITS SERVICE LIFE.  
DO NOT DISPOSE THE UNIT AS UNSORTED MUNICIPAL WASTE.**

## DELIVERY SET

Fan	— 1 pc.
Screws and dowels	— 4 pcs.
Plastic screwdriver	— 1 pc.
User's manual	— 1 pc.
Packing box	— 1 pc.

## BRIEF DESCRIPTION

The unit described herein is an axial fan for exhaust ventilation of small to medium-sized premises heated during winter. The fan fits 100 mm air ducts.

## OPERATION GUIDELINES

The fan is connected to 100...240 V/50 (60) Hz single-phase AC mains and is designed for continuous operation without disconnection from the electric mains. Air motion direction in the system must match the pointer on the fan casing. The fan is designed for indoor application with the ambient temperature ranging from +1 °C up to +45 °C.

Ingress protection rating against access to hazardous parts and water ingress is IP44.

The fan design is regularly improved, so some models may slightly differ from those ones described herein.

## DESIGNATION KEY

<b>100</b>	<b>Style Eco</b>	<b>LED</b>	
			<b>Backlight of the unit's interior</b> (only for the fans with the LED option)
			<b>Fan series</b>
			<b>Outlet duct diameter [mm]</b>

## INSTALLATION AND SET-UP

The fan is designed for wall mounting with direct air exhaust to the ventilation shaft or into the round air duct of matching diameter. Fan installation with direct air discharge upwards is not allowed (Fig. 2).

Fan installation sequence:

**Step 1.** Cut off power supply and make sure electricity has been turned off (Fig. 3).

**Step 2.** Run the power cable to the vent hole (Fig. 4).

**Step 3.** Remove the front panel from the fan (Fig. 5).

**Step 4.** Mark and drill holes for mounting the fan and then install the fan (Fig. 6-8).

**Step 5.** Remove the two fixing screws that retain the cover to enable access to the terminals. Route the power cable as shown in Fig. 9 and connect the fan to power mains in compliance with the external wiring diagram, see page 8. Fix the power cable and the signal cables with a cable clamp. After completion of the electrical connection re-install the cover in site.

**Step 6.** Install the cover and the front panel back to the fan casing (Fig. 10).

**Step 7.** Supply power voltage to the fan (Fig. 11).

## CONNECTION TO POWER MAINS



**DISCONNECT THE UNIT FROM POWER MAINS PRIOR TO ANY OPERATIONS. THE UNIT MUST BE CONNECTED TO POWER MAINS BY A QUALIFIED ELECTRICIAN. THE RATED ELECTRICAL PARAMETERS OF THE UNIT ARE GIVEN ON THE MANUFACTURER'S LABEL.**

The fan is rated for connection to single-phase AC 100-240 V/50 (60) Hz power mains.

For electric installations use insulated, durable and heat-resistant electric leads (cables, conductors) with the minimum cross section 0.5 up to 0.75 mm<sup>2</sup> for the power cable and 0.25 mm<sup>2</sup> for the control cables. The cable cross-section is given for reference only.

Use copper wires for all the electric connections! Connect the unit to power mains via the terminal block in compliance with the wiring diagram and terminal designation.

Connect the unit to power mains through the external automatic circuit breaker with a magnetic trip integrated into the fixed wiring system.

### WIRING DIAGRAM

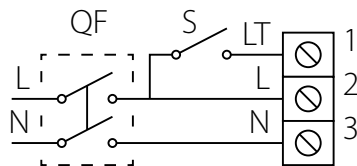

### TERMINAL DESIGNATIONS ON THE WIRING DIAGRAM

**L** — phase

**N** — 0

**LT** — fan speed control circuit

**QF** — automatic circuit breaker

**S** — switch for speed change



## FAN CONTROL

The fan is controlled by the application on the mobile device. The application is available for download at [App Store](#), [Play Market](#) or via the QR code.



App Store download link



Play Market download link

Your mobile device must have an operating system matching the following parameters:

- iOS – 7 or later. Compatible with iPhone, iPad, iPod.
- Android – 4 or later.

By default, the fan operates as a Wi-Fi access point. After installing the application, connect the mobile device to the fan as to a Wi-Fi access point (FAN: + 16 characters of the ID number) indicated on the control board and on the fan casing.

**Wi-Fi access point password:** 11111111.

Run the installed application on the mobile device connected to the fan. When starting the application, a message on the absence of communication with the fan appears on the screen if the device is not connected to the fan.

### WARNING!

No communication with device!  
Check the Wi-Fi connection.

## SETTING CONNECTION WITH THE APP

Select a desired connection type.

1. Enter the app menu.

2. Select **Connection-Connection list**.

3. If the fan is operating in Wi-Fi access point mode, select the **Default** connection. Connection is initiated automatically.

4. If the fan is connected to a home Wi-Fi network, search for devices on the network.

5. In the list, you will see a connection with the ID number of the fan. Highlight it.

6. If necessary, change the connection name.

7. Save the updated details.

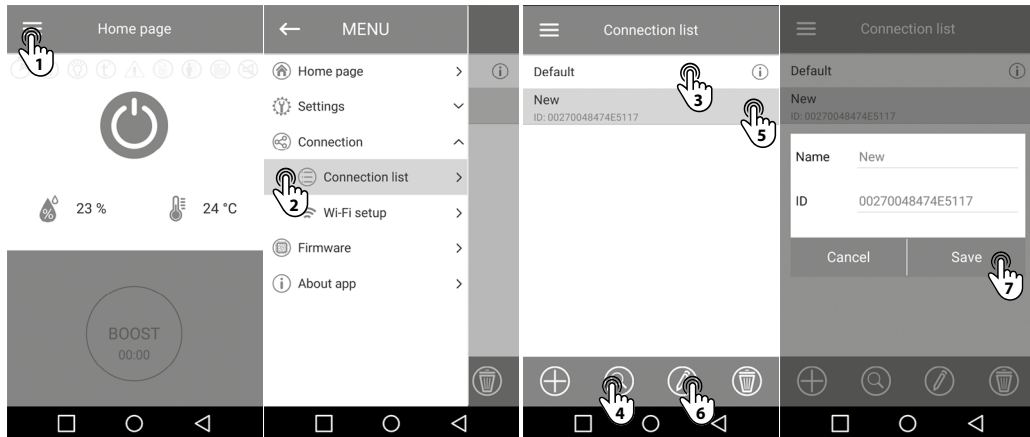

## WI-FI PARAMETER SETUP

Go to the application menu on your mobile device **Menu – Connection – Wi-Fi setup**. Then, press **Receive**. The screen will display the current Wi-Fi parameter settings. Select one of the Wi-Fi operation modes: **Access Point** or **Client**.

**Access Point** — access point mode without a home router. In this mode, up to 8 mobile devices can be connected to the fan to control it.

Select the desired security level for the **Access Point** mode:

- **Open** — open Wi-Fi network without a password.
- **WPA PSK** — password-protected. Encryption technology, using the WPA protocol, which does not guarantee complete security.
- **WPA2 PSK** — type of data encryption for modern network devices.
- **WPA/WPA2 PSK** — password-protected (recommended). Combined technology that activates **WPA** and **WPA2** and at the same time provides maximum compatibility with any of your devices
- Enter your access point password and press the **APPLY** button.

**Client** — the fan operates on the home router network. Enter the home router details for the **Client** mode. Enter the name of the Wi-Fi home router access point. Enter the password for the Wi-Fi home router **Access Point**. Then press the **APPLY** button.

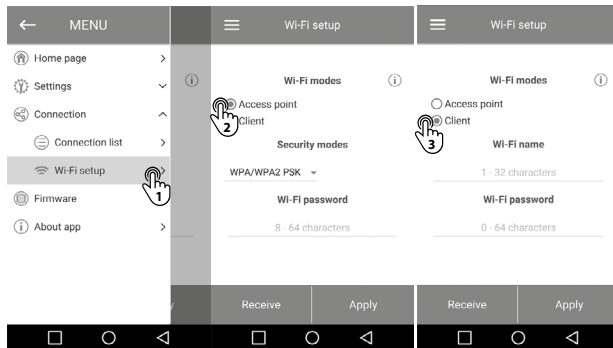

## SPECIAL «SETUP MODE/RESET»

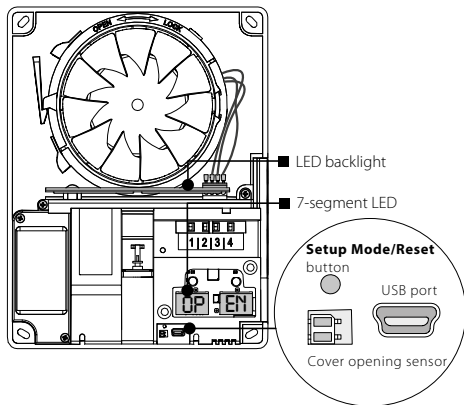

The LED has the following states:

- **Switched off.** Normal operation mode of the device.
- **Glowing blue.** Warning of switching the device to the Setup Mode.
- **Blinking blue.** The device is in Setup Mode.
- **Glowing red.** Warning of return to factory settings or exit from the Setup Mode.
- **Blinking red.** All the fan parameters are successfully reset to factory settings.

To restore the Wi-Fi password or connect to the fan in order to change the settings, **Setup Mode** is provided.

When the cover is open, the cover opening sensor trips disabling the motor, the actuator and the LED backlight. The 7-segment LED indicator displays the message «OPEN». The **Setup Mode/Reset** button is available for selection. To enter the **Setup Mode**, press the corresponding button. The 7-segment display will show «SET.» and the LED backlight will turn blue, warning the user about possibility of switching the fan to the **Setup Mode**. If the button is pressed for more than 5 seconds, the «SET.» message and the LED backlight will start blinking, notifying of successful switching to the **Setup Mode**. The unit will continue in this mode for 3 minutes and then automatically revert to the previous settings. To immediately exit the **Setup Mode**, press and hold the button again for 4 seconds.

The LED backlight will stop blinking and the «**RES.**» message will appear on the 7-segment LED indicator. The LED backlight will turn red, informing the user about the exit from the **Setup Mode**.

**Wi-Fi name:** Setup Mode.

**Wi-Fi password:** 11111111.

To return to factory settings, keep the button pressed for another 4 seconds, until the backlight and message on the 7-segment indicator start blinking, and until the acoustic signal is sounded.

### BATTERY REPLACEMENT

If the battery is low or dead, the corresponding warning indicator  appears on the home page in the application (see page 14). If this indicator appears on the home page, replace the battery. Power off the unit before replacing the battery. After replacing the battery re-set the time and date.

**Battery type:** CR1220 (located on the control board).

## HOME PAGE

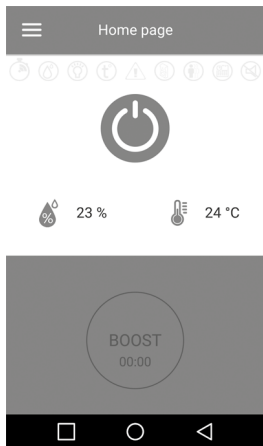









Turning the fan on/off





Switching the **BOOST** mode on/off. The timer is set in the menu **Settings – Timers** (turn-on and turn-off delay timer). The speed is set in the menu **Settings – Modes** (Max speed).

## Indicators:

-  — turn-on or turn-off delay timer operation indicator
-  — humidity exceeding indicator
-  — light sensor indicator
-  — temperature rise indicator
-  — warning indicator (battery needs replacing)
-  — external switch operation indicator
-  — motion sensor indicator
-  — Interval ventilation mode indicator
-  — Do Not Disturb mode indicator

## Sensor readings:

-  — current temperature
-  — current humidity

## RESTORE FACTORY DEFAULT SETTINGS

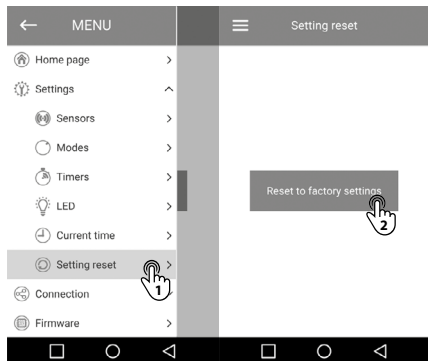

To restore the factory settings, go to the menu **Settings – Setting reset**. Then press the **Reset to factory settings** button. After restore, connection with device may be lost due to Wi-Fi settings reset. If necessary, reset your Wi-Fi connection.

You can also reset the settings using the **Setup Mode/Reset** button.

## FIRMWARE

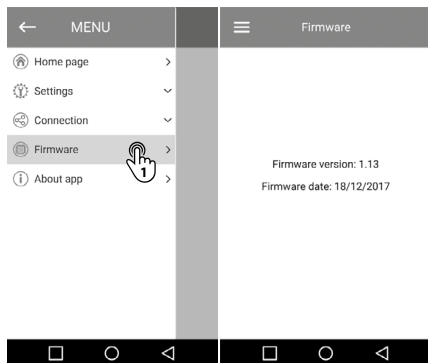

To view the firmware version, go to the menu **Settings-Firmware**. This menu displays the current firmware version and date.

## CLOCK WITH CURRENT TIME

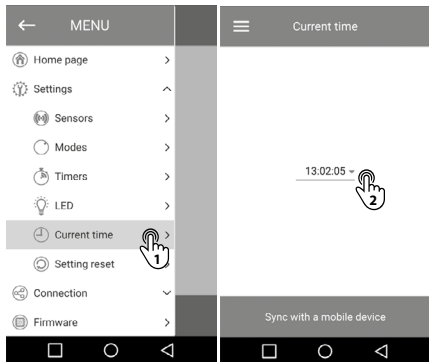

To set the clock for the current time, go to the **Settings - Current time** menu. Current time is used to indicate the time and operation of some scheduled modes (see **Modes**). When the fan is disconnected from the mains, the clock continues to operate from an internal power source (battery).

## LED (only for the fans with the LED option)

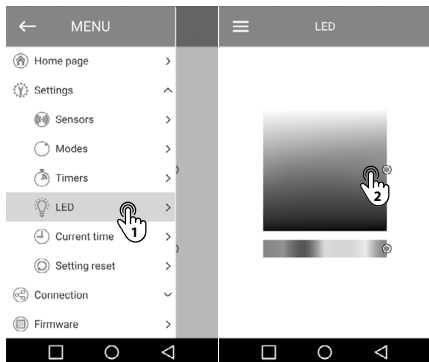

To adjust the LED backlight, go to the menu **Settings - LED**. The LED backlight is activated when the device is in operating mode (power is supplied, the device is not turned off from the application). The backlight fulfils a decorative and an indication function. The brightness of the backlight, as well as the hue can be selected from the application in the LED menu.



## SENSOR OPERATION SETUP

When setting up the sensors, take into account that it is possible to select the operation by a temperature sensor or any other sensors (humidity or an external switch).

### Adjustment of operation based on temperature sensor

Go to the menu **Settings – Sensors**, set and activate the temperature sensor. Thereafter, adjustment of other sensors is not possible.

Then set the temperature threshold. If the temperature threshold is exceeded longer than the turn-on delay timer, the fan will switch to the **MAX** high speed to remove excess heat. After the room temperature drops 4 °C below the set threshold, the fan switches to the previous mode.

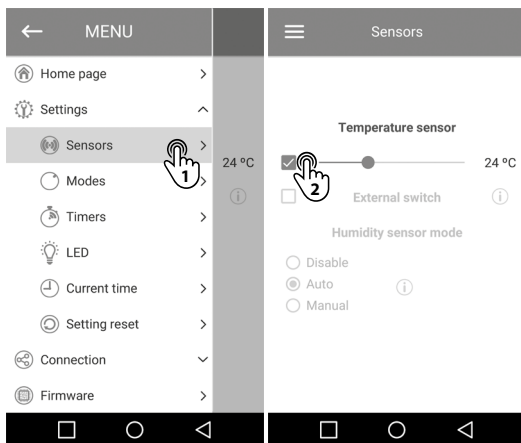

## Adjustment of operation based on humidity sensor

This mode is available only when operation by a temperature sensor is turned off.

Three modes are available:

**Disable** — the humidity sensor is deactivated.

**Auto** — intelligent humidity control. This mode provides for changing the humidity threshold and fan speed selection in automatic mode with an option to independently choose the optimal threshold for the room where the fan is located. Fan operation algorithm is selected based on analysing the statistical data of indoor humidity level.

**Manual** — manual mode, which allows you to set the threshold in the range of 40 % to 80 %. If the threshold is exceeded for more than the set turn-on delay timer, the fan switches to the **Max** high speed.

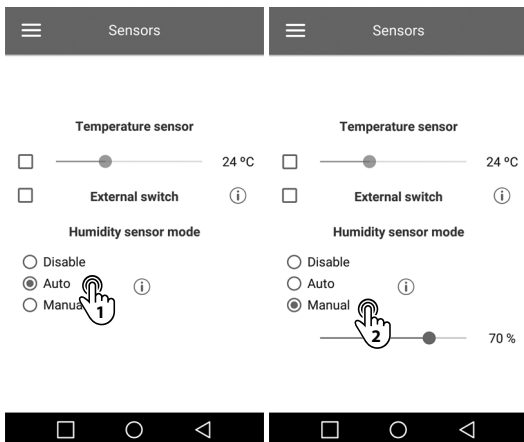

## Adjustment of operation based on external switch

Go to the menu **Settings – Sensors** and activate the external switch.

If this sensor selection is inactive, then deactivate the temperature sensor first. If a signal from the external switch appears for longer than the set turn-on delay time, the fan will go to the preset **Silent** speed. When the signal from the external switch is not registered any more, the fan will return to the previous operating mode (after turn-off delay time expires).

## OPERATION MODES

To configure the operating modes, go to the menu **Settings – Modes**.

**24 hours** — when this mode is activated, the fan is on and operates at minimum speed.

When sensors are triggered, the fan will go to a higher speed.

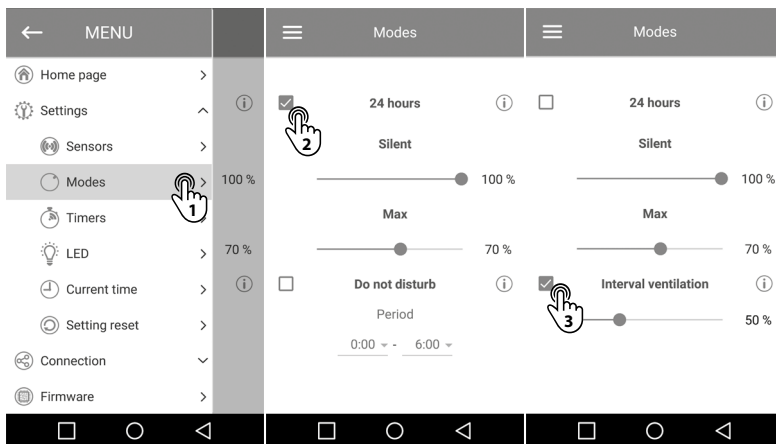

**Silent** — fan speed for **Silent** mode.

The speed is set from 30 % to 100 % of the total fan capacity.

**Max** — fan speed for **Max** mode. The speed is set from 30 % to 100 % of the total fan capacity.

**Do not disturb** — the function is only available when the 24 hours mode is activated. This function allows for setting the time interval so that the fan will not respond to sensors or switch triggering, and will operate at minimum speed.

**Interval ventilation** — the function is only available when the **24 hours** mode is deactivated. The function allows ventilation in the room every 12 hours for 30 minutes at the set speed, if during the previous day the fan wasn't turned on to one of the sensors. The interval ventilation speed is adjusted by the slider after the function is activated.

**Boost Mode** — the function is available from all the modes with the cover closed (except for the off mode) and in any sensor state. Activated/deactivated from the main screen of the application. Performs a forced switching to a high speed (**Max**) from any current operating mode. The speed can be adjusted with the Vents Fan application in the range from 30 % to 100 %.

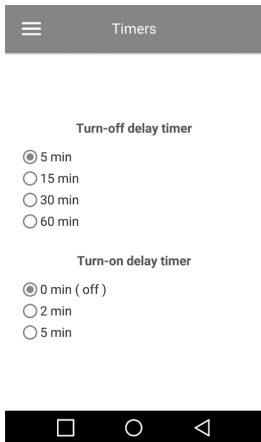

## TIMER SETUP

To configure the timers, go to the menu **Settings – Timers**.

**Turn-off delay timer** is designed to prolong the fan operation in the mode caused by sensor triggering or **Boost Mode** activation, after sensor threshold values are not exceeded any more.

The operating time of the timer may be terminated:

- When the timer expires.
- When the sensor that caused the delay is disconnected (if other sensors are not activated and do not exceed the threshold).
- When the **Boost** button is manually turned off from the application (only when **Boost Mode** is activated).
- When the fan is deactivated from the application or the switch on the fan casing.

**Turn-on delay timer** is designed to delay the transition to increased speed when the sensors are triggered.

## MAINTENANCE

The fan maintenance periodicity is at least once per 6 months.

Maintenance steps:

- Disconnect the fan from power supply and make sure electricity has been turned off (Fig. 12).
- Remove the front cover by pressing on the lower latch (Fig. 13).
- Disconnect the connector from the circuit board. While removing the connector do not pull the cable. Uplift it with a flat screw driver of a respective size (Fig. 14).
- Clean the fan with a soft dry cloth or a brush (Fig. 15).
- Clean the front cover under running water and wipe the fan surfaces dry (Fig. 16).
- Cover the fan with the front panel.
- Connect power supply (Fig. 17) and then turn on the fan from the mobile application.

**CAUTION! Do not allow water or liquid come into contact with electric components!**

## STORAGE AND TRANSPORTATION REGULATIONS

- Store the unit in the manufacturer's original packaging box in a dry closed ventilated premise with temperature range from +5 °C to +40 °C and relative humidity up to 70 %.
- Storage environment must not contain aggressive vapours and chemical mixtures provoking corrosion, insulation, and sealing deformation.
- Use suitable hoist machinery for handling and storage operations to prevent possible damage to the unit.
- Follow the handling requirements applicable for the particular type of cargo.
- The unit can be carried in the original packaging by any mode of transport provided proper protection against precipitation and mechanical damage. The unit must be transported only in the working position.
- Avoid sharp blows, scratches, or rough handling during loading and unloading.
- Prior to the initial power-up after transportation at low temperatures allow the unit to warm up at room temperature for at least 3-4 hours.

## MANUFACTURER'S WARRANTY

The product is in compliance with EU norms and standards on low voltage guidelines and electromagnetic compatibility. We hereby declare that the product complies with the provisions of Electromagnetic Council Directive 2014/30/EU, Low Voltage Directive 2014/35/EU and CE-marking Directive 93/68/EEC. This certificate is issued following test carried out on samples of the product referred to above.

The manufacturer hereby warrants normal operation of the unit for 60 months after the retail sale date provided the user's observance of the transportation, storage, installation, and operation regulations. Should any malfunctions occur in the course of the unit operation through the Manufacturer's fault during the guaranteed period of operation, the user is entitled to get all the faults eliminated by the manufacturer by means of warranty repair at the factory free of charge. The warranty repair includes work specific to elimination of faults in the unit operation to ensure its intended use by the user within the guaranteed period of operation. The faults are eliminated by means of replacement or repair of the unit components or a specific part of such unit component.

### **The warranty repair does not include:**

- routine technical maintenance
- unit installation/dismantling
- unit setup

To benefit from warranty repair, the user must provide the unit, the user's manual with the purchase date stamp, and the payment paperwork certifying the purchase. The unit model must comply with the one stated in the user's manual. Contact

the Seller for warranty service.

### **The manufacturer's warranty does not apply to the following cases:**

- User's failure to submit the unit with the entire delivery package as stated in the user's manual including submission with missing component parts previously dismounted by the user.
- Mismatch of the unit model and the brand name with the information stated on the unit packaging and in the user's manual.
- User's failure to ensure timely technical maintenance of the unit.
- External damage to the unit casing (excluding external modifications as required for installation) and internal components caused by the user.

- Redesign or engineering changes to the unit.
- Replacement and use of any assemblies, parts and components not approved by the manufacturer.
- Unit misuse.
- Violation of the unit installation regulations by the user.
- Violation of the unit control regulations by the user.
- Unit connection to power mains with a voltage different from the one stated in the user's manual.
- Unit breakdown due to voltage surges in power mains.
- Discretionary repair of the unit by the user.
- Unit repair by any persons without the manufacturer's authorization.
- Expiration of the unit warranty period.
- Violation of the unit transportation regulations by the user.
- Violation of the unit storage regulations by the user.
- Wrongful actions against the unit committed by third parties.
- Unit breakdown due to circumstances of insuperable force (fire, flood, earthquake, war, hostilities of any kind, blockades).
- Missing seals if provided by the user's manual.
- Failure to submit the user's manual with the unit purchase date stamp.
- Missing payment paperwork certifying the unit purchase.



**FOLLOWING THE REGULATIONS STIPULATED HEREIN WILL ENSURE A LONG AND TROUBLE-FREE OPERATION OF THE UNIT.**



**USER'S WARRANTY CLAIMS SHALL BE SUBJECT TO REVIEW ONLY UPON PRESENTATION OF THE UNIT, THE PAYMENT DOCUMENT AND THE USER'S MANUAL WITH THE PURCHASE DATE STAMP.**



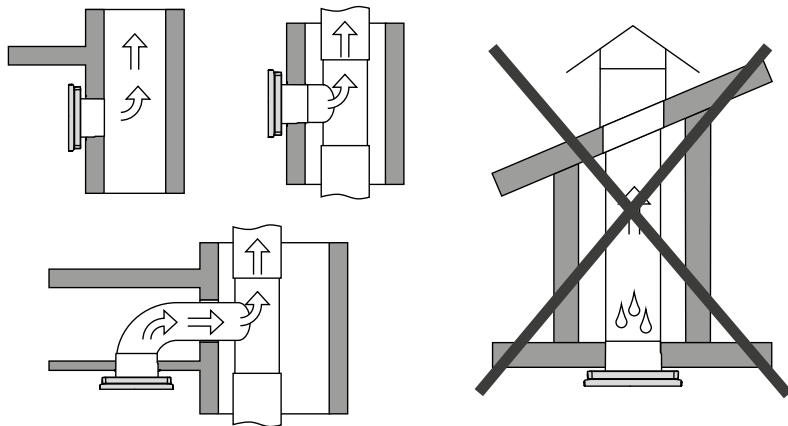
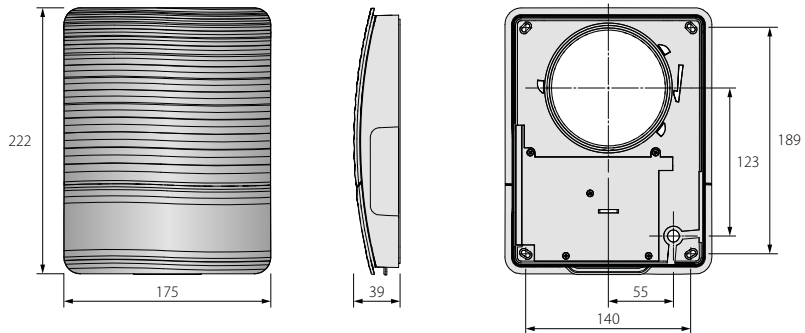

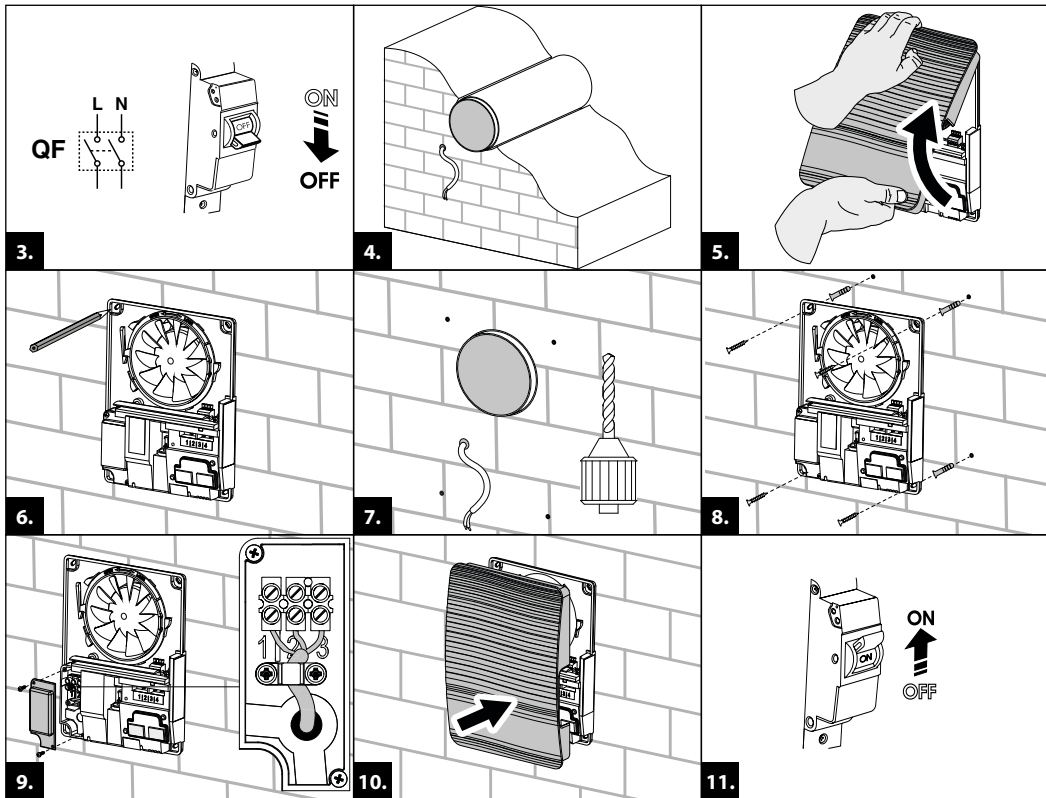

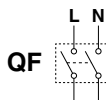

12.

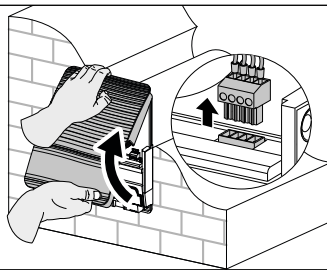

13.

Do not pull on the electric cable.

Use a flat screwdriver to disconnect the socket.

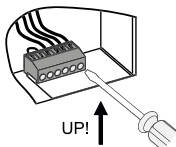
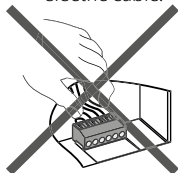

14.

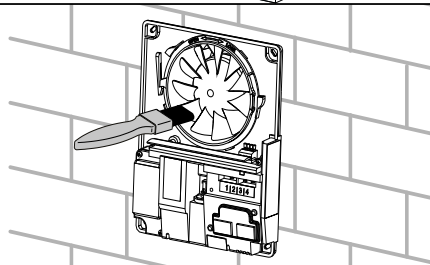

15.

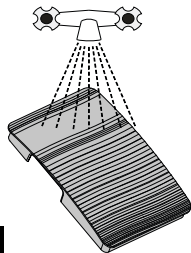

16.

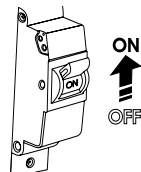

17.

Quality Inspector's Stamp

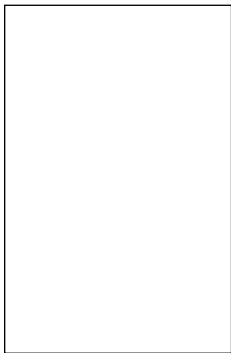

Sold by  
(name and stamp of the seller)



Manufacture Date

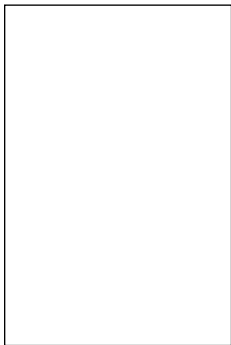

Purchase Date









Certificate of acceptance

100 Style Eco  LED 

The fan is recognized as serviceable.