

# VUT EH EC

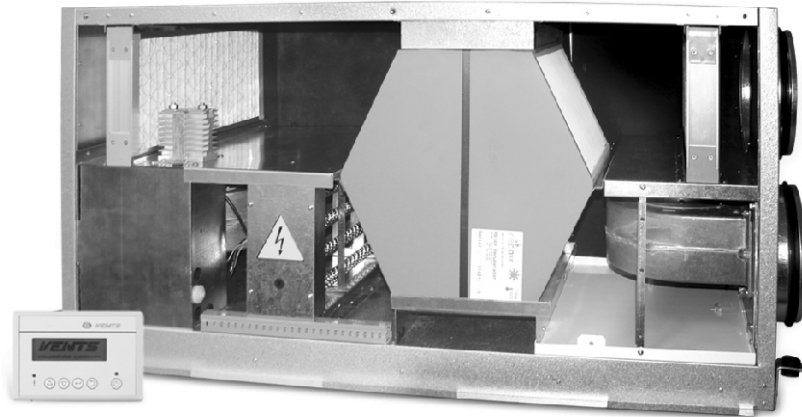

## USER'S MANUAL



**CONTENT**

1	Introduction	p.3
2	Purpose	p.3
3	Delivery set	p.3
4	Designation key	p.4
5	Parameters and dimensions	p.4
6	Technical data	p.6
7	Safety requirements	p.8
8	Design and functioning	p.9
9	Mounting and set-up	p.11
10	Unit connection and control	p.12
11	Condensate drainage	p.13
12	Wiring diagram	p.15
13	Control panel connection	p.16
14	Unit activation/deactivation	p.18
15	Control	p.18
16	Control panel operation	p.20
17	Unit programming with the external control panel	p.21
18	Error status	p.31
19	Maintenance	p.32
20	Troubleshooting	p.34
21	Storage and transportation rules	p.36
22	Manufacturer's warranty and acceptance certificate	p.36
23	Seller information	p.37
24	Connection certificate	p.38
25	Warranty card	p.38

The user's manual consisting of the technical details, operating instructions and technical specification applies to the installation and mounting of the heat recovery air handling unit VENTS VUT EH EC, hereinafter " the unit".

## INTRODUCTION

Due to the ability to save heating energy by means of energy recovery the unit is an important element of energy-efficient premises.

The unit is a component part and is not designed for independent operation.

The unit is designed to ensure continuous mechanical air exchange in houses, offices, hotels, cafes, conference halls and other utility and public spaces as well as to recover the heat energy contained in the air extracted from the premises to warm up the filtered supply air.

## PURPOSE

The unit is rated for continuous operation.

Transported air must not contain any flammable or explosive mixtures, evaporation of chemicals, sticky substances, fibrous materials, coarse dust, soot and oil particles or environments favourable for the formation of hazardous substances (toxic substances, dust, pathogenic germs).

**THE UNIT MAY NOT BE OPERATED BY CHILDREN OR PERSONS WITH REDUCED PHYSICAL, MENTAL OR SENSORY CAPACITIES, OR LACKING THE APPROPRIATE TRAINING. THE UNIT MUST BE INSTALLED AND CONNECTED ONLY BY PROPERLY QUALIFIED PERSONNEL AFTER THE APPROPRIATE BRIEFING. THE CHOICE OF UNIT INSTALLATION LOCATION MUST PREVENT UNAUTHORIZED ACCESS BY UNATTENDED CHILDREN.**



The delivery set includes:

Heat recovery air handling unit - 1 item.

Remote mounted control panel - 1 item.

(10 m connecting cable)

User's manual - 1 item.

Packing box - 1 item.

## DELIVERY SET

**DESIGNATION  
KEY**

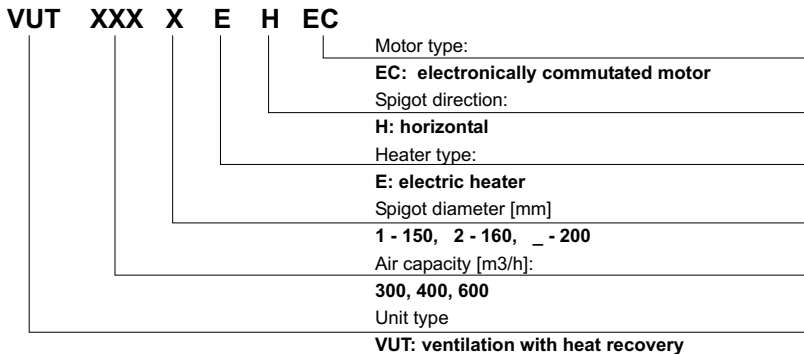

**Designation example:**

Ventilation unit with heat recovery and air capacity 300 m3/h, horizontally directed 160 mm spigots, equipped with an electric heater and EC motors:

**VENTS VUT 300-2 EH EC.**

**BASIC  
PARAMETERS  
AND DIMENSIONS**

The basic unit dimensions are stated in Table 1 and in Fig. 1.

The basic unit parameters and characteristics are stated in the Tables 1.1 and 1.2.

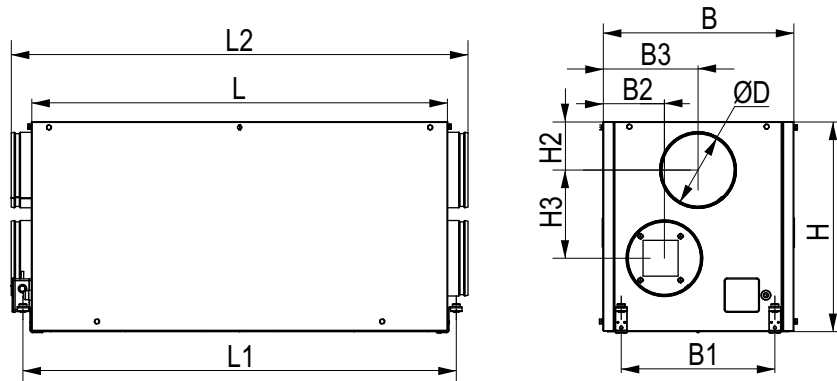

Fig. 1

Model	Dimensions [mm]										
	$\varnothing D$	B	B1	B2	B3	H	H2	H3	L	L1	L2
VUT 300-1 EH EC	149	500	403	161	249	555	127	231	1092	1137	1198
VUT 300-2 EH EC	159	500	403	161	249	555	127	231	1092	1137	1198
VUT 400 EH EC	199	500	403	161	249	555	127	231	1092	1137	1198
VUT 600 EH EC	199	500	403	161	249	555	127	231	1092	1137	1198

Table 1.

**TECHNICAL  
DATA**

The unit is rated for indoor application with the ambient temperatures from +1°C up to +40°C and relative humidity of up to 80%.

Hazardous parts access and water ingress protection ratings:

Unit motors - IP 44;

Unit assembly connected to air ducts - IP 22.

	VUT 300-1 EH EC	VUT 300-2 EH EC
Unit supply voltage, 50/60 Hz [V]	1~ 230	
Max. fan power [W]	2 items x 70	
Fan current [A]	2 items x 0,60	
Electric heater power [kW]	3,0	
Electric heater current [A]	13,0	
Total unit power [kW]	3,14	
Total unit current [A]	14,2	
Max. air capacity [m3/h]	300	
PRM [min-1]	1380	
Sound pressure level at 3 m distance [dB(A)]	24-45	
Transported air temperature [°C]	from- 25 up to +60	
Casing material	Aluzinc	
Insulation	25 mm, mineral wool	
Extract filter	G4	
Supply filter	F7 (Eu 7)	
Connected air duct diameter [mm]	ø 150	ø 160
Weight [kg]	38	
Heat recovery efficiency	max. 90%	
Heat exchanger type	counter-flow	
Heat exchanger material	polystyrene	

Table 1.1.

	VUT 400 EH EC	VUT 600 EH EC
Unit supply voltage, 50/60 Hz [V]		1~230
Max. fan power [W]		2 items x 175
Fan current [A]		2 items x 1,3
Electric heater power [kW]		4,0
Electric heater current [A]		17,4
Total unit power [kW]		4,35
Total unit current [A]		20,0
Max. air capacity [m <sup>3</sup> /h]	400	600
PRM [min-1]	1340	2150
Sound pressure level at 3 m distance [dB(A)]		28-47
Transported air temperature [°C]		from- 25 up to +60
Casing material		Aluzinc
Insulation		25 mm, mineral wool
Extract filter		G4
Supply filter		F7 (Eu7)
Connected air duct diameter [mm]		ø 200
Weight [kg]		38
Heat recovery efficiency		max. 90%
Heat exchanger type		counter-flow
Heat exchanger material		polystyrene

Table 1.2.

**SAFETY  
REQUIREMENTS**

**Read the user's manual carefully prior to installing and operating the heat recovery air handling unit, hereinafter referred as the unit.**

**Fulfil the user's manual requirements as well as the provisions of all the applicable local and national construction, electrical and technical norms and standards.**

**The warnings contained in the user's manual must be considered most seriously since they contain vital personal safety information.**

**Failure to follow the rules and safety precautions noted in this user's manual may result in an injury or unit damage.**

**After a careful reading of the manual, keep it for the entire service life of the unit.**

**While transferring the unit control the User's manual must be turned over to the receiving operator.**

**WARNING**

Disconnect the unit from power mains prior to any installation, servicing, electric connection or repair operations.

**WARNING**

Do not operate the unit in the air and dust mixture medium!

**RESTRICTIONS!**

Do not operate the unit outside the temperature range stated in the user's manual.  
Do not operate the unit in aggressive or explosive environments.

**RESTRICTIONS!**

Do not connect a clothes dryer or other similar equipment to the ventilation system.



**The unit operates as follows:**

Warm stale extract air from the room flows to the unit, where it is filtered, then air flows through the heat exchanger and is exhausted outside by the extract fan.  
Clean cold air from outside is moved by the supply filter.

Then filtered air flows through the heat exchanger and is moved to the room with the supply fan.

Heat energy of warm extract air is transferred to clean intake fresh air from outside and warms it up.

The air flows remain fully separated within the heat exchanger.

Heat and energy recovery minimizes heat losses and ensure humidity balance, thus reducing expenses for heating in the cold seasons and air conditioning in the warm season.

The unit is a frame structure consisting of six 25 mm thick rigidly fixed aluzinc sandwich panels, internally filled with mineral wool for sound insulation.

The unit components: the quick detachable specially sealed service panels 14 provide maintenance access; the side casing panels 13 with a terminal box 15 fixed to the outer surface of one them.

The terminal box incorporates a terminal block (not shown in Fig. 2) with the wires routed from the circuit control board.

The sealed cable gland is used for routing of power and ground cables from the unit and connection to the terminal block.

The wiring diagram for connection of the air handling unit is shown on inner side of the terminal box lid.

**The basic unit complete set includes:**

- remote-mounted control panel 9 that is connected via the data cable 12 to the integrated control system in the unit;
- a supply 1 and an extract 2 centrifugal single-intake fans with backward curved blades and maintenance-free external rotor motors with built-in overheating protection.
- plate counter-flow heat exchanger. It may be temporary replaced with a summer block for a season requiring no heat recovery.
- one electric air heater. Two integrated thermal switches, one of safety type with response temperature +50 °C and automatic reset and another of emergency type with response temperature +90 °C and manual reset.
- supply filter 4 with filter class G4 or F7 and extract filter 5 with filter class G4.  
The supply filter prevent ingress of contaminants from the outdoor air to the room and prevent the unit components from contamination.  
The extract air filters protect the unit components from contamination.

The filter replacement warning is shown by the lamp indicator on the control panel.

The filter replacement periodicity is set from 10 up to 99 days on the control panel.

During heat recovery condensate may be generated.

Condensate is collected in the drain pan 11 and flows outside via the drain pipe 6.

**VENTS ... EH EC  
UNIT DESIGN**

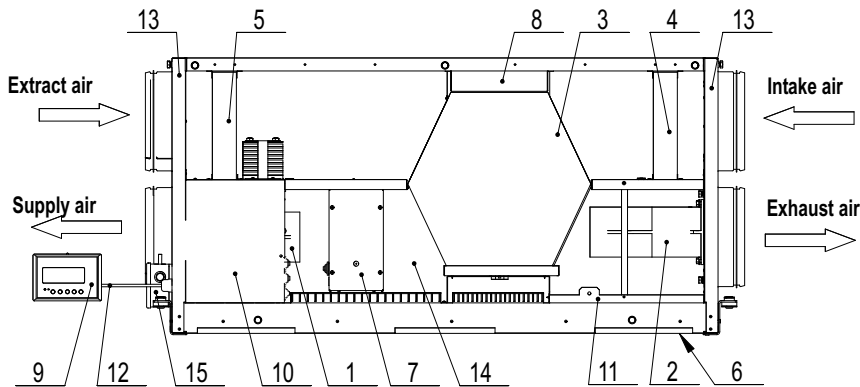

Fig. 2

- |  |   |
|--|---|
| 1 - Supply fan;                        | 8 - Bypass damper;                        |
| 2 - Extract fan;                       | 9 - Remote-mounted control panel;         |
| 3 - Plate counter-flow heat exchanger; | 10 - Casing with integrated control unit; |
| 4 - Supply filter;                     | 11 - Drain pan;                           |
| 5 - Extract filter;                    | 12 - Data cable;                          |
| 6 - Drain pipe;                        | 13 - Side unit panels;                    |
| 7 - Electric heater;                   | 14 - Quick-detachable panels;             |
|  | 15 - Terminal box.                        |

## MOUNTING AND SET-UP

The unit is designed for ceiling mounting by means of the threaded rod fixed inside the threaded dowel (Fig. 3). Optionally, it may be rigidly fixed on a horizontal even surface (Fig. 4). Mount the unit to provide enough access for maintenance or repair operations. For the minimum distances from the unit to the walls, refer to the Fig. 5.

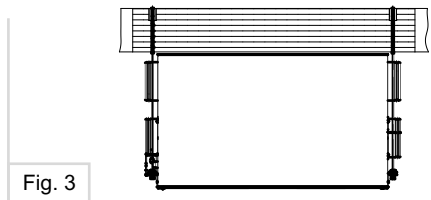

Fig. 3

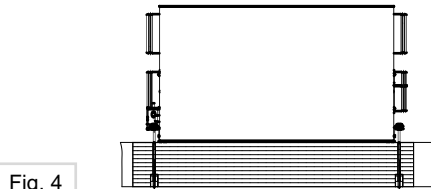

Fig. 4

The minimum distance for service access to the unit

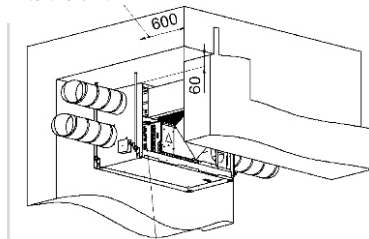

Fig. 5 Location of electronic control unit

To attain the best performance of the unit and to minimise turbulence-induced air pressure losses while mounting connect the straight air duct section to the spigots on both sides of the unit.

Minimum straight air duct length:  
 equal to 1 air duct diameter on intake air spigot.  
 equal to 3 air duct diameter on supply air spigot.

If the unit supply and exhaust spigots are not connected to air ducts, these must be covered with a grille or with another protecting device with maximum mesh width 12.5 mm to prevent free access to the unit fans.

After the unit mounting it must be connected to a drain system as shown in Fig. 6. The unit must be sloped down toward the drain pipe by 1-2°.

Connect the drain pipe (1), the U-trap (3) and the sewerage system (5) with metal, plastic or rubber hoses. The hoses (2,4) must be installed at the minimum downward slope of 3°, i.e. 1 m pipe must be sloped down by 55 mm.

Before starting the unit fill the drain system with water and check that the U-trap is always filled with water.

Make sure that the water drainage is correct. Wrong connection to sewage system may result in condensate accumulation inside the unit. The condensate drainage system is designed for operation at the ambient temperature above 0 °C!

If the ambient temperature is below 0 °C, the condensate drainage system must be heat insulated and pre-heated.

### CONDENSATE DRAINAGE

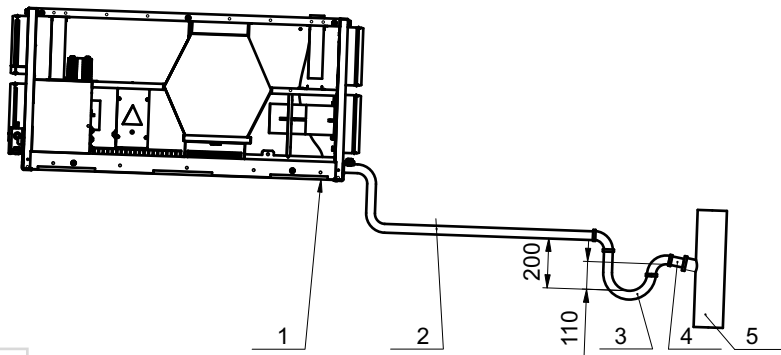

Fig. 6

**WARNING**

Do not connect several drain pipes from several air handling units to a single U-trap!  
Direct condensate drainage outside without connection to sewage system is not allowed.

**Disconnect the unit from power supply prior to any electric installation operations. Installation shall only be performed by a professional electrician. The rated electrical parameters are stated on the rating plate. Any tampering with the internal connections is prohibited and will void the warranty.**

**CONNECTION  
TO POWER  
MAINS**

The unit is rated for connection to AC single-phase 230 V / 50/60 Hz power mains. The electric connection must be performed using durable, insulated and heat-resistant conductors (cables and wires) with minimum cross section 2.5 mm<sup>2</sup>.

The given conductor section value is tentative. In practice the cable core selection shall be based on the maximum permissible wire heating depending on the wire type, its insulation, length and installation method (i.e. overhead, in pipes or inside the walls).

Connect the unit to power supply on the terminal block located in the terminal box on the unit side wall, in compliance with the wiring diagram and terminal designation in Fig. 7. Route the cables to the terminal block in the terminal box on the unit side wall through the electric lead-in to preserve the electrical protection class.

The external power input (230 V / 50/60 Hz) must be equipped with an automatic thermal-magnetic circuit breaker built into the stationary wiring to disconnect all the power mains phases.

The mounting place of the automatic circuit breaker QF must ensure prompt access for emergency shutdown of the unit.

The trip current of the circuit breaker must match the unit consumption current. Recommended circuit breaker trip current.

16 A (for VUT 300-1 EH EC and VUT 300-2 EH EC)

25 A (for VUT 400 EH EC and VUT 600 EH EC).

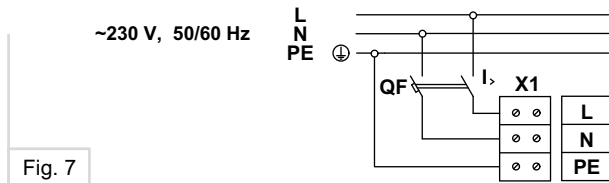

### CONNECTION OF CONTROL PANEL

The temperature sensor is integrated in the control panel. Therefore, the installation place of the control panel must be at least 1 m away from heating equipment, doors and windows. Attach the control panel to the wall using the supplied screws.

The control panel is supplied to the control unit with the supplied standard four-wire 10 m cable.

The data cable connecting the control panel and the unit shall be routed separately from the power cables. The recommended minimum distance between the cables is 150 mm.

The control panel is delivered assembled and pre-wired to the control unit. In case of need to re-assemble the control panel please follow the steps below.

Disassemble the control panel:

- Press the side latches to open the control panel;
- Disconnect the cable from the terminal block using the screwdriver (Fig. 8);
- Open the cable clamp on the mounting frame using cutting pliers;
- Remove the cable and mount the cable as required.

Complete mounting of the control panel (Fig. 8):

- Route the cable through the access hole in the bottom lid;
- Fix the control panel back lid in the installation place and ensure a secure fit of the lid to the wall by tightening the self-tapping screw.

The screw head must not be in contact with the control circuit board, otherwise causing a risk of equipment damage!



- c) Strip the cable of the protective insulation (~20 mm);
- d) Strip the wires of the protective insulation (~6 mm);
- e) Attach the wires to the terminal block on the control board according to the markings on the sticker and the wire colouring:

Black	.....	⊥
Red	.....	A
Green	.....	B
Yellow	.....	+

- f) fix the cable on the mounting base using the cable clamp (not included in the delivery set);
- g) Snap the control panel casing in place.

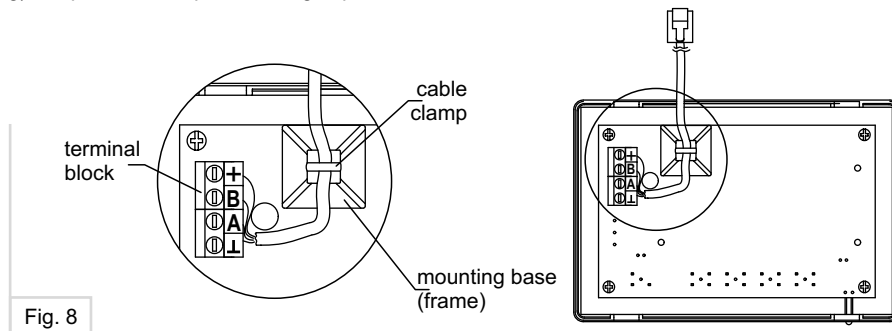

On the unit side, route the cable with the connector via the electric sealed lead-in in the terminal box and snap it in the socket (Fig. 9, item 1) or connect the wires to the contacts of the socket connector (Fig. 9, item 2), depending on the control panel modification. The unit connection is performed with a socket connector (Fig. 9, item 2).

The unit is equipped with thermal resistors. These parts are included in the delivery set and are pre-installed at factory. Therefore, there is no need to connect a duct sensor.

**Functional capabilities.**

The system enables to control air capacity of the supply and extract fan in 3 speed steps:

- 1 - low speed;
- 2 - medium speed;
- 3 - maximum speed.

2. The temperature sensors enable to select the most suitable operation mode for maintaining a pre-set air temperature in the air duct.
3. The control panel is equipped with a temperature sensor thereby enabling maintaining of the set (user-defined) indoor temperature at the selected fan speed or in accordance with the set service function mode (see below). The required operation mode setting as well as the current parameters (i.e. indoor temperature, set temperature, fan speed and heater power) are shown on the LCD display.
4. The energy-saving optimization program calculates the heater power required to sustain the indoor temperature with up to 1°C accuracy while adjusting the heater power to 1%.
5. The air bypass damper prevents freezing of the heat exchanger at low supply air temperature and, if necessary, disables intake air entering the heat exchanger in the cold ventilation mode (heat exchanger bypass mode).
6. The system status monitoring program controls the operating parameters of the unit and initiates emergency shutdown in dangerous situations (i.e. heater overheating or communication loss) by sending corresponding signals to the control panel. Filter replacement warnings are displayed at user-defined intervals (see below).
7. The control panel enables to control various extra connected devices as duct heaters, dampers, etc.

Control board

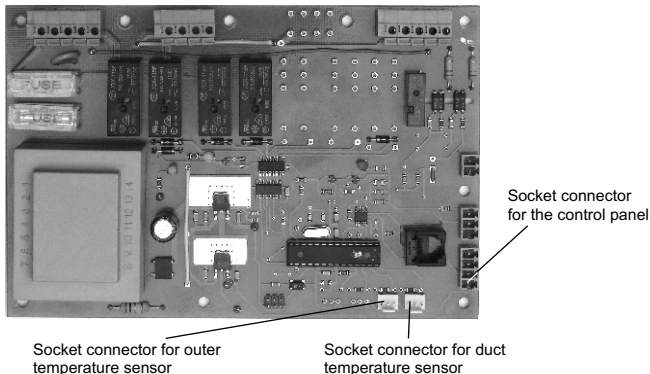

Fig. 9

Connect the unit to the power mains 1~230 V/50/60 Hz (for details, refer to connection to power mains). The indicator displays the “VENTS” logo, the LED indicators are off. To activate the unit press the Power button, select On and press the Enter button. This green LED goes on, the current operation mode is activated and the control panel indicator displays the main operation window information. To deactivate the unit press the Power button, select Off and press the Enter button. The unit switches to the heating elements cooling mode (green LED is blinking) and goes off in 2 minutes. The operation parameters are selected and edited via the user menu, see the details below.

**UNIT  
ACTIVATION/  
DEACTIVATION**

The unit is controlled via the remote-mounted control panel. The physical "control panel-unit" data transfer channel is performed via a four-core data cable up to 10 m in length. The unit has a digital data transfer.

**UNIT  
CONTROL**

### Service functions.

The service functions of the control system are as follows:

1. The week scheduled program enables automatic programming of the user-defined parameters as indoor temperature, fan speed for each week day and current time. This function provides automatic changeover between day and night modes as well as "week days" and "week end" and is easy to program for each week day.
2. The day scheduled program enables automated activation and deactivation of the unit in a user-defined time.
3. The heat exchanger operation mode changeover enables to control the unit operation depending on the Winter or Summer season.
4. Regular filter replacement must be performed to ensure cleanliness of the supply filter. The automation system possesses the function of the filter replacement timer to enable timely replacement of the filter.

### OPERATING THE CONTROL PANEL

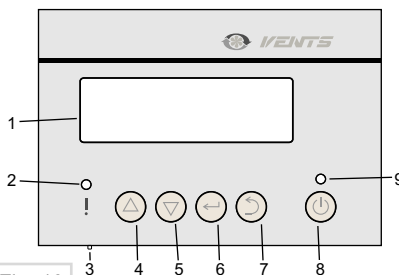
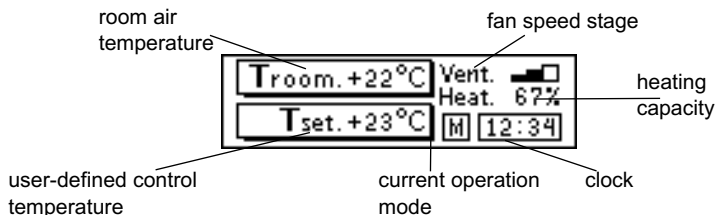

Fig. 10

1. LCD display.
2. Red LED indicator. Its steady glow indicates an alarm or a fault and its blinking indicates the need to replace the filter.
3. Temperature sensor.
4. "Up" button is used for going up in the list of menu or increasing the current parameter.

5. "Down" button is used for going down in the list of menu or decreasing the current parameter.
6. "Enter" button is used for selection of an editable parameter or moving to a previous menu level. In the working window it indicates entrance to the menu.
7. "Escape" button is used for return to higher menu level. In the working window it enables to select the interface language.
8. "Power" button is used to control the unit status (on/off).
9. Green LED indicator. Its steady glow indicates active status of the unit, its blinking means the heater cooling is ON. It is off when the unit is OFF.

During rated operating conditions the control panel displays the following parameters:



**PROGRAMMING OF  
THE OPERATIONS  
MODES WITH THE  
LCD CONTROL  
PANEL**

Press Escape to get to interface language menu and use the Up/Down buttons to select a required language. Press Enter to save the new language setting. If no button is pressed for 10 seconds or Escape button is pressed the menu language is not changed and the main working window is displayed.

The user menu has two levels, the main menu and the service menu. Press Enter to get to the menu from the main working window.

Use the Up/Down buttons for navigation in the menu items. Press Escape to return to a previous level and to come back to the main working window. Press Enter to enter the next menu item and edit parameters. The basic operating parameters are available for editing in the main menu:

**“Temperature setting”**



Enables to edit the control temperature value with the Up/Down buttons.

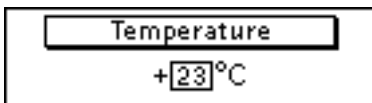

**“Fan speed “**



Enables to edit the fan speed stage with the Up/Down buttons.



The service menu is used to use and adjust the service functions:



Date and time settings are required to ensure the correct operation of the day timer and the week timer.

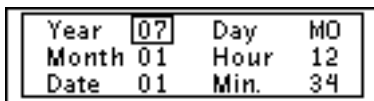

To select the item to be edited (year, month, date, day, hour, minute) press Enter.  
To edit the current value of the menu item use the Up/Down buttons.

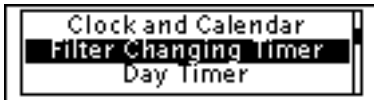

Enables to set a filter replacement interval.  
After it elapses the control panel reminds of the filter replacement.

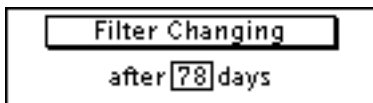

Use the Up/Down buttons to set the filter replacement periodicity.

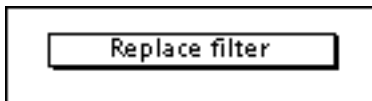

The filter replacement warning indicator is displayed instead of the main working window for some time. Synchronously the red LED indicator blinks. To deactivate the filter replacement indicator enter the menu item "Filter replacement timer" and press Enter.

The next filter replacement warning appears in set time period.  
During the active indication the air handling unit operates normally.

### "Day Timer"





Is used to set turning ON and turning OFF time for the air handling unit.

When this mode is activated the unit turns on and off in set time every day till this mode is deactivated. The item "Operation mode" in the main window will display the symbol "D" to confirm that the day timer is activated.

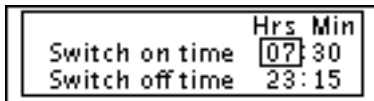

To select the item to be edited (turning ON or turning OFF time, hours, minutes) press Enter.  
To edit the current value of the menu item use the Up/Down buttons.

### "Week timer"

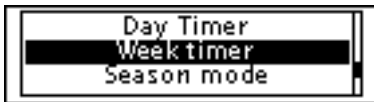

Is used to program operation mode of the air handling unit for any week day.

If this mode is activated, the unit changes its speed and control temperature automatically in set time and in set days. The item "Operation mode" in the main window will display the symbol "W" to confirm that the week timer is activated.

**WARNING**

The day timer settings have higher priority as compared to the week timer. If the day timer is activated the item "Operation mode" in the main window will display the symbol "D".

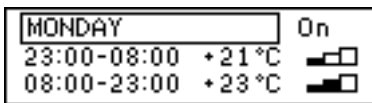

To select the item to be edited (week day, on/off timer status for this day, operation time in this mode, control temperature, fan speed) press Enter. To edit the current value of the menu item use the Up/Down buttons.

**Week operation programming example.**

The required operation schedule for the air handling unit is as follows:

**MONDAY**

Set the room temperature 24 °C from 08:00 till 23:00 and set the medium speed for the supply fan.

Set the room temperature 21 °C from 23:00 till 08:00 and set the minimum speed for the supply fan.

**TUESDAY**

Set the room temperature 23 °C from 09:00 till 22:00 and set the maximum speed for the supply fan.

Set the room temperature 20 °C from 22:00 till 09:00 set the room temperature 20 °C and set the minimum speed for the supply fan.

**WEDNESDAY**

disable

**THURSDAY**

disable

**FRIDAY**

Set the room temperature 25 °C from 09:00 till 22:00 and set the maximum speed for the supply fan.

Set the room temperature 19 °C from 22:00 till 09:00 and set the minimum speed for the supply fan.

**SATURDAY**

disable

**SUNDAY**

disable

Enter the week scheduled mode, select "ON" and press Enter.

The week programming window will be displayed.

Operation mode programming for MONDAY:

In the week day selection window, first line, set "MONDAY" using the Up/Down buttons and press Enter. The cursor bar goes to the timer status for the selected week day.

Set "ON" with the Up/Down buttons and press Enter. The cursor bar goes to the activation time settings for the "day" period, second line.

Set 08:00 with the Up/Down buttons and press Enter. The cursor bar goes to the supply fan speed settings in the "day" period.

Set 24 with the Up/Down buttons and press Enter. The cursor bar goes to the room temperature settings in the "day" period.

Set medium fan speed (two vertical bars) with the Up/Down buttons and press Enter.

The cursor bar goes to the activation time settings for the "night" period, third line.

Set 23:00 with the Up/Down buttons and press Enter. The cursor bar goes to the room temperature settings in the "night" period.

Set 21 with the Up/Down buttons and press Enter. The cursor bar goes to the supply fan speed settings in the "night" time. Set the minimum speed (one vertical bar)

with the buttons Up/Down and press Enter. The cursor bar goes to the week day selection window, first line.

#### Operation mode programming for TUESDAY:

In the week day selection window, first line, set "TUESDAY" using the Up/Down buttons and press Enter. The cursor bar goes to the timer status for the selected week day.

Set "ON" with the Up/Down buttons and press Enter. The cursor bar goes to the activation time settings for the "day" period, second line.

Set 09:00 with the Up/Down buttons and press Enter. The cursor bar goes to the room temperature settings in the "day" period.

Set 23 with the Up/Down buttons and press Enter. The cursor bar goes to the supply fan speed settings in the "day" time.

Set the maximum speed (three vertical bars) with the buttons Up/Down and press Enter. The cursor bar goes to the activation time settings for the "night" period, third line.

Set 22:00 with the Up/Down buttons and press Enter. The cursor bar goes to the room temperature settings in the "night" period.

Set 20 with the Up/Down buttons and press Enter. The cursor bar goes to the supply fan speed settings in the "night" time.

Set the minimum speed (one vertical bar) with the buttons Up/Down and press Enter. The cursor bar goes to the week day selection window, first line.

#### Operation mode programming for WEDNESDAY:

In the week day selection window, first line, set "WEDNESDAY" using the Up/Down buttons and press Enter. The cursor bar goes to the timer status for the selected week day.

Set "OFF" with the Up/Down buttons and press Enter. The cursor bar reverts to the week day selection window, first line.

#### Operation mode programming for THURSDAY:

In the week day selection window, first line, set "THURSDAY" using the Up/Down buttons and press Enter. The cursor bar goes to the timer status for the selected week day.

Set "OFF" with the Up/Down buttons and press Enter. The cursor bar reverts to the week day selection window, first line.

#### Operation mode programming for FRIDAY:

In the week day selection window, first line, set "FRIDAY" using the Up/Down buttons and press Enter. The cursor bar goes to the timer status for the selected week day.

Set "ON" with the Up/Down buttons and press Enter. The cursor bar goes to the activation time settings for the "day" period, second line.

Set 09:00 with the Up/Down buttons and press Enter. The cursor bar goes to the room temperature settings in the "day" period.

Set 25 with the Up/Down buttons and press Enter. The cursor bar goes to the supply fan speed settings in the "day" time.

Set the maximum speed (three vertical bars) with the Up/Down buttons and press Enter. The cursor bar goes to the activation time settings for the "night" period, third line.

Set 20:00 with the Up/Down buttons and press Enter. The cursor bar goes to the room temperature settings in the "night" period.

Set 19 with the Up/Down buttons and press Enter. The cursor bar goes to the supply fan speed settings in the "night" time.

Set the minimum speed (one vertical bar) with the buttons Up/Down and press Enter. The cursor bar goes to the week day selection window, first line.

#### Operation mode programming for SATURDAY:

In the week day selection window, first line, set "SATURDAY" using the Up/Down buttons and press Enter. The cursor bar goes to the timer status for the selected week day.

Set "OFF" with the Up/Down buttons and press Enter. The cursor bar reverts to the week day selection window, first line.

#### Operation mode programming for SUNDAY:

In the week day selection window, first line, set "SUNDAY" using the Up/Down buttons and press Enter. The cursor bar goes to the timer status for the selected week day.

Set "OFF" with the Up/Down buttons and press Enter. The cursor bar reverts to the week day selection window, first line.

**"Season mode"**



This mode is applicable only for the unit with a heat exchanger and a bypass damper



In "heat recovery (winter) mode" the bypass damper is closed and the intake air stream flows through the heat exchanger. In case of a freezing danger of the heat exchanger, if the intake air temperature is below -9 °C, the bypass damper is open for 5 minutes and closed for 25 minutes. This operation modes disables heat exchanger freezing.

In "no heat recovery (summer)" mode the bypass damper is always open. Press the Power button to switch to the activation/deactivation mode of the unit.



Select the required position using the Up/Down buttons or the Power button and then press Enter to bring the unit to the required status (on/off). The procedure of the unit turning on is the following:

the electric heater is turned off, the fan switches to low speed for heater cooling.

Synchronously, the green LED indicator blinks.

During this mode the excessive heat is removed from the heating elements to prevent actuation of the overheat protection thermostats.

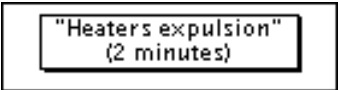

"Heaters expulsion"  
(2 minutes)

The units turns off in 2 minutes.

In case of actuation of any of the two overheat protection thermostats, in case of filter contamination communicated by the differential pressure switch, in case of communication loss the unit has an emergency shutdown. The electric heater cooling mode is activated and turns off after 2 minutes. The red LED indicator lights up and a respective alarm indicator is displayed:

**FAILURE**

**Faultiness!!!**

"Heaters Overheating"  
Unit is switched off

or

**Faultiness!!!**

"Filter is soiled"  
Unit is switched off

or

**Faultiness!!!**

"Communication is absent"  
Unit is switched off

To restart the unit, disconnect power supply and troubleshoot a failure.

**MAINTENANCE**

The unit requires maintenance works 3-4 times per year. Maintenance includes regular cleaning and the following operations:

**1. Filter maintenance.**

Contaminated filters increase air resistance in the system and reduce supply air volume. Clean the filters once in 3-4 months. Clean the filters with a vacuum cleaner or replace with a new filter after two cleanings (once or twice per year). Contact the Seller for spare filters.

**2. Heat exchanger maintenance (once a year).**

Even regular technical maintenance of the filters as in clause 1 may not completely prevent dirt accumulation on the heat exchanger casing. Clean the heat exchanger on a regular basis to ensure high heat recovery efficiency. Wash the heat exchangers with warm neutral detergent solution.

**3. Fan maintenance (once a year).**

Even regular technical maintenance may not completely prevent dirt accumulation in the fans which reduces the fan capacity and impairs supply air delivery into the premises. Clean the fans with a soft cloth or a brush. Do not use water, aggressive solvents or sharp objects as they may damage the impeller.

**4. Condensate drain check (once a year).**

The condensate drain (line) may get clogged by dirt and dust particles contained in the extract air. Check the drain line operation by filling the drain pan under the unit with water, clean the U-trap and the drain line, if necessary.



**5. Extract shutters and supply diffuser cleaning (as required).**

Remove the diffusers and louvre shutters and wash those with hot soap water. Do not change the mounting position of the diffusers and the shutters.

**6. Fresh air supply duct check.**

The supply duct grille may get clogged with leaves and other objects reducing the unit performance and supply air delivery. Check the supply grille twice a year and clean it as required.

**7. Air ductworks maintenance.**

Even regular filter replacement may not completely prevent dirt accumulation in the air ducts which reduces the unit capacity. The air duct maintenance includes their regular cleaning.

**Check the outer hood and the intake grille once a year and clean those as required.**

**WARNING**

**TROUBLE-SHOOTING**

<b>Problem</b>	<b>Possible reasons</b>	<b>Remedy</b>
<p>The fan does not move up during start-up of the unit.</p>	<p>Motor jam in one or both fans. Wrong wiring of the control panel or any other unit components.</p>	<p>Turn the unit off. Troubleshoot the motor jam. Restart the unit.</p>
<p>Circuit breaker tripping during the ventilator start-up.</p>	<p>Overcurrent as a result of short circuit in the electric circuit.</p>	<p>Turn the unit off. Check the circuit breaker status by turning it on and off. Restart the unit. Contact the Seller for further information regarding overcurrent in the electric circuit.</p>
<p>Low air flow.</p>	<p>Contaminated filters. Contaminated air disc valves, louvre shutters, ventilation grilles, air ducts and other system components. Contaminated fans, heater exchanger or other unit components. Damaged air ducts. Closed air dampers, air disc valves or louvre shutters.</p>	<p>Clean or replace the filters. Clean or replace disc valves, louvre shutters, ventilation grilles, air ducts and other system components. Clean the fans, the heater exchanger or other unit components. Make sure the air ducts are intact and the air dampers, air disc valves and louvre shutters are fully open.</p>

<b>Problem</b>	<b>Possible reasons</b>	<b>Remedy</b>
Cold air flow.	Contaminated filters. Heat exchanger icing. Tripping of the temperature switch. Wrong selected ventilation system.	Clean or replace the filters. Check the heat exchanger for icing. In case of the heat exchanger icing turn the unit off and let the ice melt. To prevent subsequent icing increase the response temperature of the thermal switch.
Noise, vibration.	Contaminated fans. Loose screw connection. No anti-vibration mounts are installed.	Clean the fans. Check the screw connection and tighten the screws if required. Use the anti-vibration mounts for the unit mounting (available as specially ordered accessories).
Water leakage.	The drainage system is soiled, damaged or frozen. Wrong mounting angle of the unit or the drain system.	Check the mounting angle of the unit toward the drain pipe. Clean the drain line, if required. Check the drain line slant, inspect the U-trap and make sure the drain line is frost protected.

**STORAGE AND  
TRANSPORTATION  
REGULATIONS**

Store the unit in the manufacturer's original packing box in a dry ventilated premise at ambient temperatures from +10 °C up to +40 °C at max. RH 60% at +20 °C. Storage environment must not contain aggressive vapours and chemical mixtures provoking corrosion, insulation and sealing deformation. Follow the handling requirements applicable for the particular type of cargo. The unit can be carried in the original packing by any mode of transport provided proper protection against precipitation and mechanical damage. Avoid sharp blows, scratches or rough handling during loading and unloading.

**MANUFACTURER'S  
WARRANTY**

The warranty period is two years from the date of retail sale provided compliance with transport, storage, mounting and operation regulations. In case of no confirmation of the sales date the warranty period is calculated from the manufacturing date. In case of failures in the unit operation during the warranty period the manufacturer will accept reclamations and complaints from the owner of the device only after receiving technically sound act with detailed description of the failure. Unit damage as a result of unauthorized tampering with the circuit diagram is not a warranty case. Warranty repair services and post-warranty services are fulfilled at the manufacturing facility.

**WARNING**

**IN CASE OF WARRANTY CLAIM PLEASE SUBMIT THE PRESENT USER'S MANUAL WITH THE SELLER'S STAMP, THE FILLED WARRANTY CARD, A PAYMENT DOCUMENT, THE PRESENT USER'S MANUAL WITH THE FILLED SALES DATE.**

The **MANUFACTURER** is not responsible for any mechanical or physical damages resulting from the manual requirements violence, the unit misuse or gross mechanical effect.

Fulfil the requirements set in the user's manual to ensure proper functioning of the unit.

**WARNING**

### ACCEPTANCE CERTIFICATE

<b>Unit type</b>	Heat recovery air handling unit
<b>Model</b>	VUT ____ EH EC
<b>Serial Number</b>	
<b>Manufacture Date</b>	
We hereby declare that the product complies with the essential protection requirements of Electromagnetic Council Directive 2004/108/EC, 89/336/EEC and Low Voltage Directive 2006/95/EC, 73/23/EEC and CE-marking Directive 93/68/EEC on the approximation of the laws of the Member States relating to electromagnetic compatibility. This certificate is issued following test carried out on samples of the product referred to above.	
<b>Quality Inspector's Stamp</b>	

**SELLER INFORMATION**

<b>Outlet Name</b>	
<b>Address</b>	
<b>Phone Number</b>	
<b>E-mail</b>	
<b>Purchase Date</b>	

This is to certify acceptance of the complete unit delivery with the user's manual. The warranty terms are acknowledged and accepted.	
<b>Customer's Signature</b>	

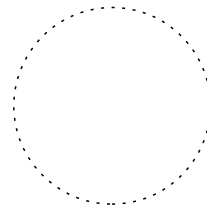

Seller's Stamp

**INSTALLATION CERTIFICATE**

The heat recovery air handling unit VUT _____ EH EC has been connected to power mains pursuant to the requirements stated in the present user's manual.	
<b>Company Name</b>	
<b>Address</b>	
<b>Phone Number</b>	
<b>Installation Technician's Full Name</b>	
<b>Installation Date:</b>	<b>Signature:</b>

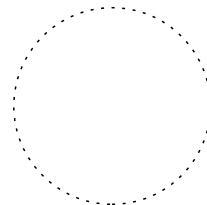

Installation Company Stamp

The unit has been installed in accordance with the provisions of all the applicable local and national construction, electrical and technical codes and standards. The unit operates normally as intended by the manufacturer.
<b>Signature:</b>

## WARRANTY CARD

<b>Unit type</b>	Heat recovery air handling unit
<b>Model</b>	VUT ____ EH EC
<b>Serial Number</b>	
<b>Purchase Date</b>	
<b>Purchase Date</b>	
<b>Warranty Period</b>	
<b>Seller</b>	

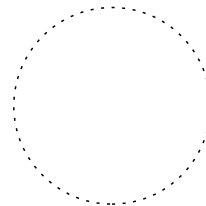

Seller's Stamp

---

---

---

---

---

---

---

---

---

---

