

USER'S MANUAL

Heat recovery air handling unit



VUT 300 E2V EC
VUT 300-2 E2V EC

CONTENTS



Safety requirements	3
Introduction	5
Purpose	5
Delivery set	5
Designation key	6
Technical data	6
Unit design and operating principle	9
Mounting and set-up	10
Condensate drainage	12
Connection to power mains	12
Unit control	14
Technical maintenance	21
Troubleshooting	24
Storage and transportation regulations	24
Manufacturer's warranty	25
Acceptance certificate	24
Seller information	26
Connection certificate	27
Warranty card	27









SAFETY REQUIREMENTS

- Read the user's manual carefully prior to the operation and installation of the heat recovery air handling unit (hereinafter referred to as «the unit»).
- Fulfil the user's manual requirements as well as the provisions of all the applicable local and national construction, electrical and technical norms and standards.
- The warnings contained in the user's manual must be considered most seriously since they contain vital personal safety information.
- Failure to follow the safety requirements noted in this user's manual may result in an injury or unit damage.
- After a careful reading of the manual, keep it for the entire service life of the unit.
- While transferring the unit control the user's manual must be turned over to the receiving operator.



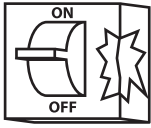

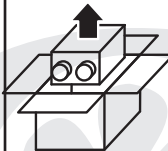

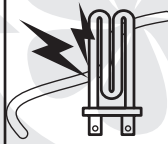
Symbol legend:

	WARNING!
	DO NOT!

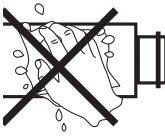
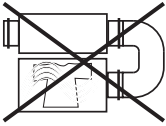
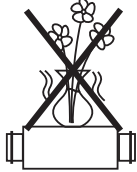
UNIT MOUNTING SAFETY PRECAUTIONS

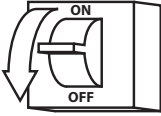
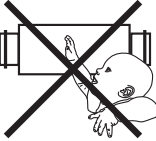
	Disconnect the unit from power mains prior to any installation or repair operations.		The unit must be grounded!
	The unit must not be operated outside the temperature range stated in the user's manual and in aggressive or explosive environments.		Do not use damaged equipment or cables when connecting the unit to power mains.
	While installing the unit follow the safety regulations specific to the use of electric tools.		Unpack the unit with care.
	Do not change the power cable length at your own discretion. Do not bend the power cable. Avoid damaging the power cable.		Do not position any heating devices or other equipment in close proximity to the unit power cable.

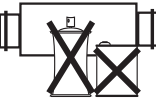
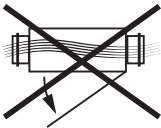
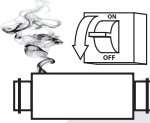
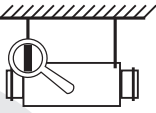
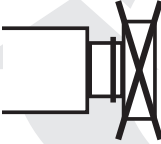
UNIT OPERATION SAFETY PRECAUTIONS

	Do not touch the unit controls with wet hands. Do not carry out the unit maintenance with wet hands.		Do not wash the unit with water. Protect the unit electric parts from water ingress.
	Use the unit only as intended by the manufacturer. Do not connect a clothes dryer or other similar equipment to the unit or the ventilation system.		Do not put any water containers on the unit, i.e. flower vases.
	Do not sit on the unit and avoid placing foreign objects on it.		Disconnect the unit from power mains prior to maintenance.
	Do not let children operate the unit.		Do not damage the power cable while operating the unit. Do not put any foreign objects on the power cable.
	Keep combustible gases and inflammable products away of the unit.		Do not open the operating unit.
	When the unit generates unusual sounds, odour or emits smoke disconnect it from power supply and contact the Seller.		In case of continuous operation of the unit periodically check the security of mounting.
	Do not block the air duct when the unit is on.		Do not let air flow from the unit be directed to the open flame devices or candles.

INTRODUCTION

This user's manual includes technical description, operation, installation and mounting guidelines, technical data for the VENTS VUT 300 E2VEC heat recovery air handling unit, hereinafter referred as «the unit».

PURPOSE

The unit is designed to ensure continuous mechanical air exchange in houses, offices, hotels, cafés, conference halls, and other utility and public spaces as well as to recover the heat energy contained in the air extracted from the premises to warm up the filtered stream of supply air.

The unit is not intended for organizing ventilation in swimming pools, saunas, greenhouses, summer gardens, and other spaces with high humidity.

Due to the ability to save heating energy by means of energy recovery, the unit is an important element of energy-efficient premises.

The unit is a component part and is not designed for stand-alone operation.

It is rated for continuous operation.

Transported air must not contain any flammable or explosive mixtures, evaporation of chemicals, sticky substances, fibrous materials, coarse dust, soot and oil particles or environments favourable for the formation of hazardous substances (toxic substances, dust, pathogenic germs).

Relative humidity of transported air must not exceed 80 % at an ambient temperature of +20 °C.



THE UNIT MAY NOT BE OPERATED BY CHILDREN OR PERSONS WITH REDUCED PHYSICAL, MENTAL OR SENSORY CAPACITIES, OR LACKING THE APPROPRIATE TRAINING.

THE UNIT MUST BE INSTALLED AND CONNECTED ONLY BY PROPERLY QUALIFIED PERSONNEL AFTER THE APPROPRIATE BRIEFING.

THE CHOICE OF UNIT INSTALLATION LOCATION MUST PREVENT UNAUTHORIZED ACCESS BY UNATTENDED CHILDREN.

DELIVERY SET

- Air handling unit - 1 item
- User's manual - 1 item
- Wall-mounted control panel - 1 item
- Remote control - 1 item
- Duct temperature sensor - 1 item
- Packing box - 1 item
- Fastening kit - 1 item

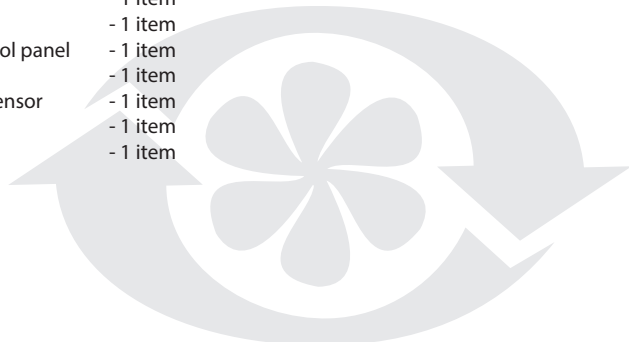

DESIGNATION KEY

VUT 300-X E 2 V EC
Motor type

electronically commutated

Spigot orientation

V - vertical

Number of heaters**Electric heater****Spigot diameter [mm]**

- - 150

2 - 160

Air capacity [m³/h]**Unit type**

VUT - ventilation with heat recovery

TECHNICAL DATA

The unit is designed for indoor application with the ambient temperature ranging from +1 °C up to +40 °C and relative humidity up to 80 %.

In order to prevent condensation on the internal walls of the units, it is necessary that the surface temperature of the casing is 2-3 °C higher than the dew point temperature of the transported air.

The unit is rated as a Class I electrical appliance.

Hazardous parts access and water ingress protection rating:

- IP44 for the unit motors
- IP22 for the assembled unit connected to the air ducts.

The main outside and connecting dimensions as well as the appearance and technical parameters of the unit are given on Figure 1 and in Table 1.

The unit design is constantly being improved, so some models may be slightly different from those ones described in this manual.



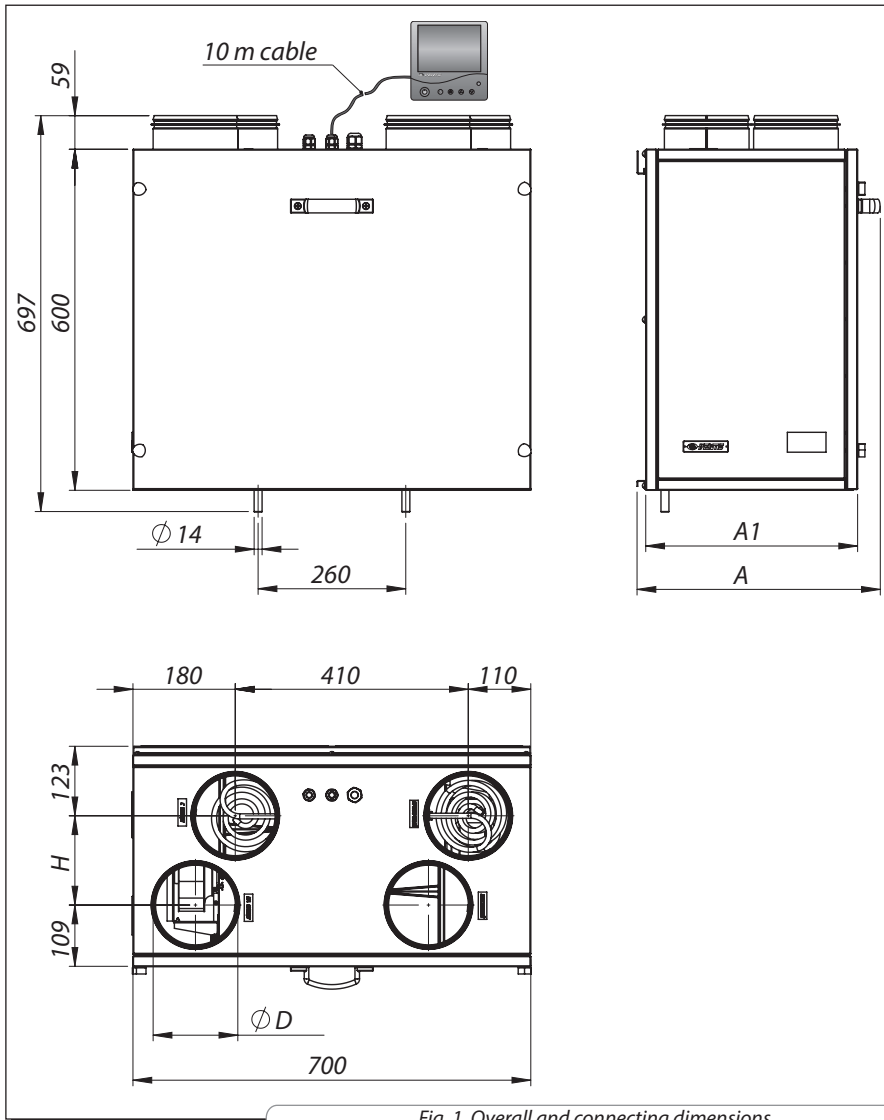

Fig. 1. Overall and connecting dimensions

Reference dimensions

Model	ΦD	A	A1	H
VUT 300 E2V EC	150	428	373	156
VUT 300-2 E2V EC	160	458	403	186

Table 1. Unit technical data

Model	VUT 300 E2V EC	VUT 300-2 E2V EC
Unit voltage [V/50(60) Hz]	1 ~ 230	
Maximum fan power [W]	212	
Fan current [A]	1.4	
Electric heater power [kW]	2 item x 2	
Electric heater current [A]	2 item x 8.7	
Total unit power [W]	4.21	
Maximum unit current [A]	18.8	
Maximum air capacity [m ³ /h]	300	
Sound pressure level at 3 m distance [dB(A)]	37	
Transported air temperature [°C]	from -25 up to +40	
Casing material	aluzinc	
Insulation	20 mm mineral wool	
Filter: extract/supply	pocket G4/G4 (F7*) replaceable filter ordering number: SFK 300 E2V EC G4/SFK 300 E2V EC F7	
Connected air ducts diameter [mm]	Ø 150	Ø 160
Weight [kg]	38	
Heat recovery efficiency [%]	from 83 up to 95	
Heat exchanger type	counter-flow	
Heat exchanger material	polystyrene	

*option

Table 2. Control panel technical data

Ambient temperature [°C]	from 0 up to 40
Relative humidity [%]	from 5 to 90 (no condensation)
Cable cross section [mm ²]	from 0.18 up to 0.35
Material	ABS-plastic
Dimensions (WxHxD) [mm]	86 x 86 x 14
Cable length [m]	up to 10
Ingress protection	IP30

DESIGN AND OPERATING PRINCIPLE

The unit operation is as follows:

Warm extract air from the room flows into the unit and is cleaned in the extract filter. Then the air is moved through the heat exchanger and is exhausted outside with the extract fan. Cold fresh air from outside flows into the unit, where it is cleaned in the supply filter. If the supply air temperature is below the value set from the control panel, supply air pre-heating is provided by the built-in electric heater. Then the air flows through the heat exchanger and is moved to the room with the supply fan. The heat exchanger transfers the heat energy of the warm extract air to the cold fresh air from outdoors. The air flows are fully separated while flowing through the heat exchanger. Heat recovery minimizes heat losses, which reduces the cost of space heating in the cold season.

The air handling unit is equipped with a 2 kW electric heater with overheating protection which provides supply air pre-heating.

The unit design and operation principle are shown in the Fig. 2.

The basic unit modification includes:

- Extract fan
- Supply fan
- Counter-flow heat exchanger
- G4 extract air filter
- G4 supply air filter
- Drain pan
- Drain pipes
- Electric heater for air preheating
- Electric heater for air post-heating
- Supply air temperature duct sensor.

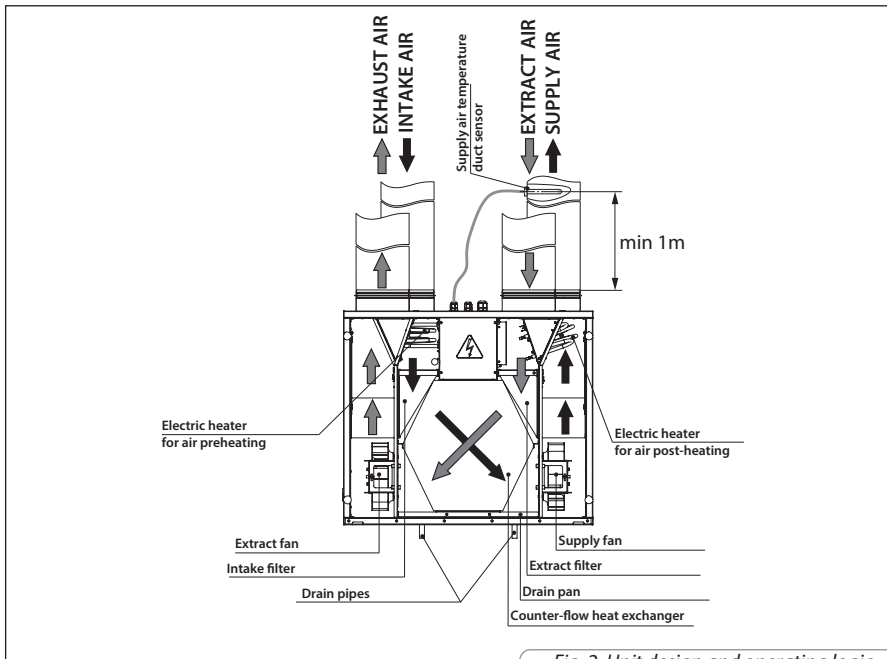

Fig. 2. Unit design and operating logic

MOUNTING AND SET-UP

The units are designed for wall mounting.

While installing the unit ensure convenient access for subsequent maintenance and repair.

The mounting surface must be smooth.

Mounting of the unit to an uneven surface can lead to the unit casing distortion and operation disturbance.

To ensure proper operation of the supply air pre-heating function install a supply air temperature duct sensor (item 11 on Fig. 2) at the minimum distance of 1 m from the pipe marked «To Indoors».

To install the supply air temperature duct sensor:

- drill a $\varnothing 9$ mm hole in the air duct;
- install the sensor into the hole;
- secure the sensor flange with three self-tapping screws.

The sensor and the air duct joint should be additionally sealed.

The air handling unit is secured to the wall with anchor bolts (see Fig. 3).

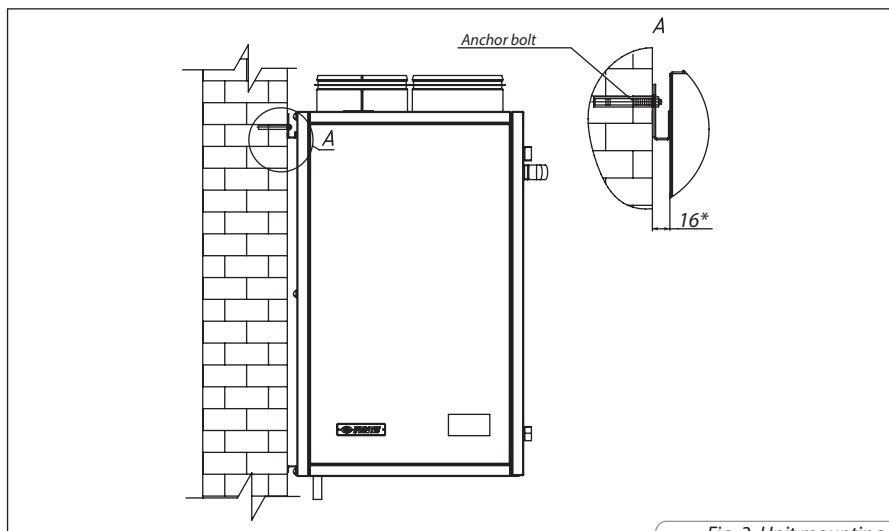

Fig. 3. Unit mounting



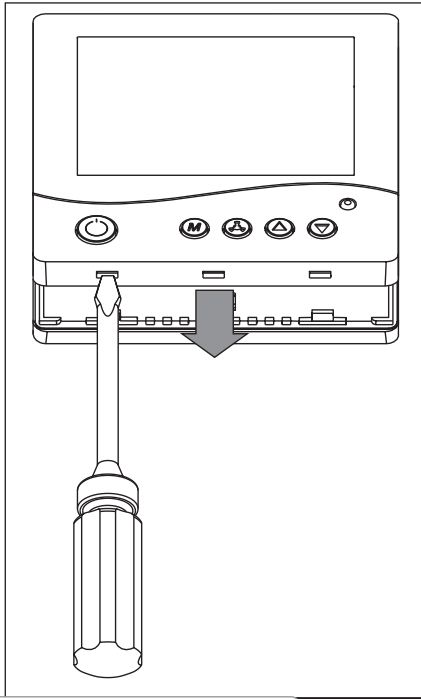

Fig. 4. Rear wall separation

The wall-mounted control panel is installed as follows:

- Carefully release the latches with a flat screwdriver by inserting it into the access holes in the lower part of the wall control panel (Fig. 4).
- Remove the service covers.
- Disconnect the cable from the terminal block.
- Route the cable in the wall to the speed switch installation site.
- Secure the rear panel cover to the wall (Fig. 5).
- Connect the cable to the terminal block. The connection diagram is given on Fig. 5.
- Latch the front part of the wall panel in place.

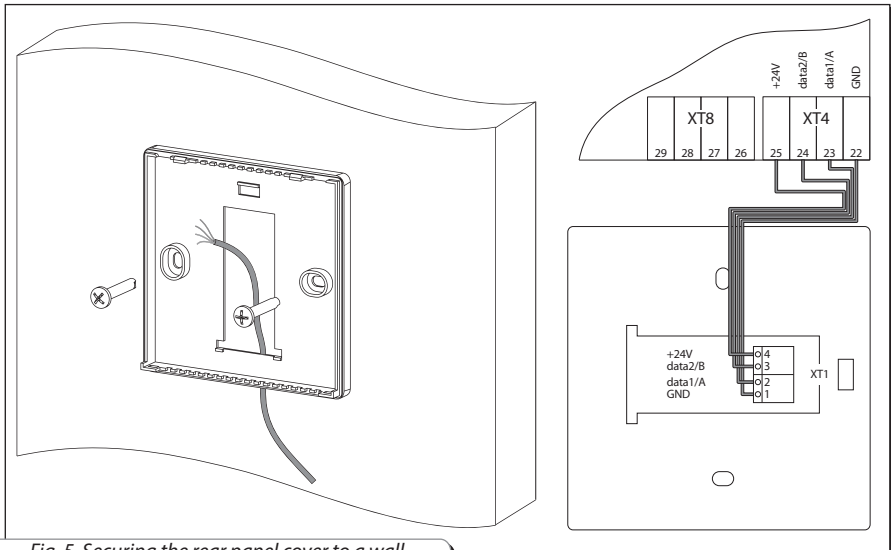

Fig. 5. Securing the rear panel cover to a wall

CONDENSATE DRAINAGE

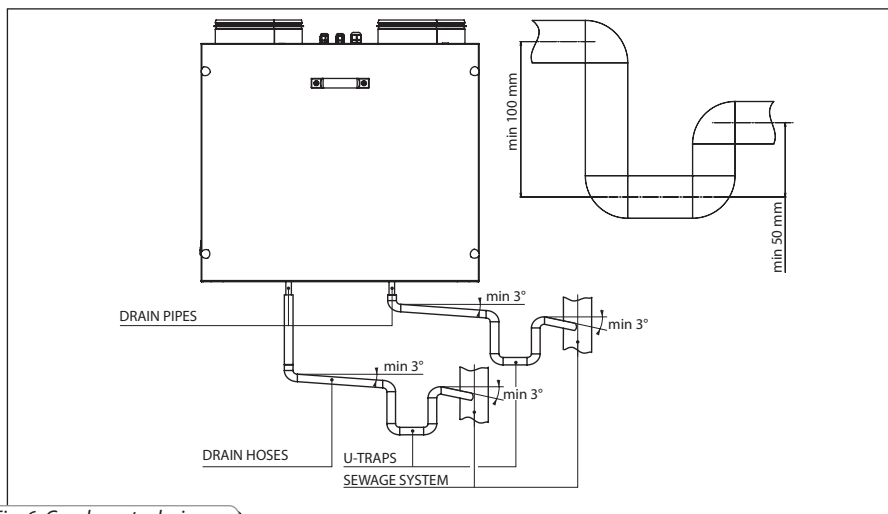

Fig. 6. Condensate drainage

The condensate drip pan installed in the heat recovery section is provided with drain pipes. Connect the drain pipe, the U-trap (not included into the delivery set) and a sewage system with metal, plastic or rubber drain hoses (Fig. 6). The pipes are required to have a minimum slope of 3°. Fill the system with water prior to connecting it to power supply! The U-trap must always be filled with water. Provide free drainage for the condensed water, otherwise it is accumulated inside the unit which may cause the equipment damage and condensate outflow to the room.

The condensate drainage system is designed for normal operation in premises with ambient temperatures above 0 °C! If the expected ambient air temperatures are below 0 °C the condensate drainage system must be equipped with heat insulation and pre-heating facilities.

CONNECTION TO POWER MAINS



THE POWER MAINS CONNECTION SHALL ONLY BE PERFORMED BY QUALIFIED PERSONNEL AFTER CAREFUL READING OF THE USER'S MANUAL.

THE AIR HANDLING UNIT MUST ONLY BE CONNECTED TO AN A/C POWER SOURCE WITH VOLTAGE OUTPUT AS SPECIFIED IN THE TECHNICAL DATA SHEET. CHECK THE ENTIRE CABLE LENGTH FOR KINKING. DO NOT SWITCH ON THE UNIT IF THE CABLE IS DAMAGED.



NEVER REMOVE THE PLUG FROM THE POWER RECEPTACLE WITH WET HANDS OR BY HOLDING ONTO THE ELECTRIC CABLE.

DISCONNECT THE UNIT FROM POWER MAINS PRIOR TO ANY OPERATIONS!

THE RATED ELECTRICAL PARAMETERS OF THE UNIT ARE SHOWN ON THE RATING PLATE.

ANY TAMPERING WITH THE INTERNAL CONNECTIONS IS PROHIBITED AND WILL VOID THE WARRANTY.

The unit is intended for connection to a 230 V / 50 (60) Hz single-phase AC mains with a 3x2.5 mm² cable connected to input terminal block XI of the unit at the factory. The wire strands of the cable are marked as follows: phase (L), neutral (N) and ground (PE).

The external lead-in (230 V / 50 Hz) must be equipped with a circuit breaker built into the stationary wiring to disconnect all the mains phases. The position of the QF external automatic circuit breaker must ensure free access for quick power-off of the unit. The minimum trip current of the automatic cut-out switch must be 20 A. The cross-section of the cable conductors is 2.5 mm².

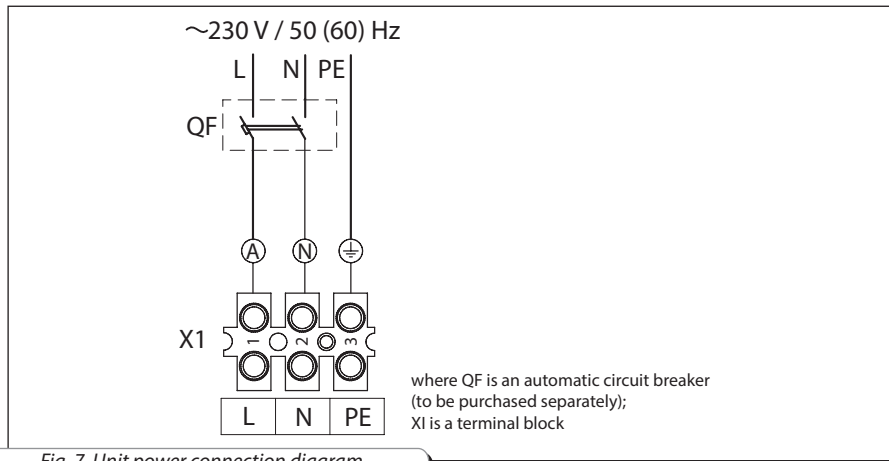

Fig. 7. Unit power connection diagram

The QF external switch location must ensure free access for quick shutdown of the fan. The cross section of the power conductors is 2.5 mm².

The unit functionality can be extended by connecting external control devices. The respective contacts are specified on the label of terminal block X3 (Fig. 8):

- contact PK for connecting an automatic fire extinguishing system;
- contact H for connecting a humidity sensor or a CO₂ sensor;
- contacts Y-N, Y-L and Y-C for connecting a 3-point control damper.

Upon connecting the automatic fire extinguishing system contact remove the jumper between terminals X3:1 and X3:2 of terminal block X3. This operation scenario relies on a normally closed dry contact which interrupts the unit control circuit and de-energises the unit in the event of a fire on the signal sent by the central fire extinguishing panel.

Humidity sensor or CO₂ sensor must be connected to terminals X3:3 and X3:4 of terminal block X3. Upon actuation of the humidity sensor or the CO₂ sensor the dry contact closes and the unit is set to maximum speed.

The damper actuator must be connected to terminals X3:5, X3:6 and X3:7 of terminal block X3. A second damper can be connected to the same contacts. Additional contacts are connected according to the connection diagram (see Fig. 8). The wires run into the unit through the cable gland in the cover.

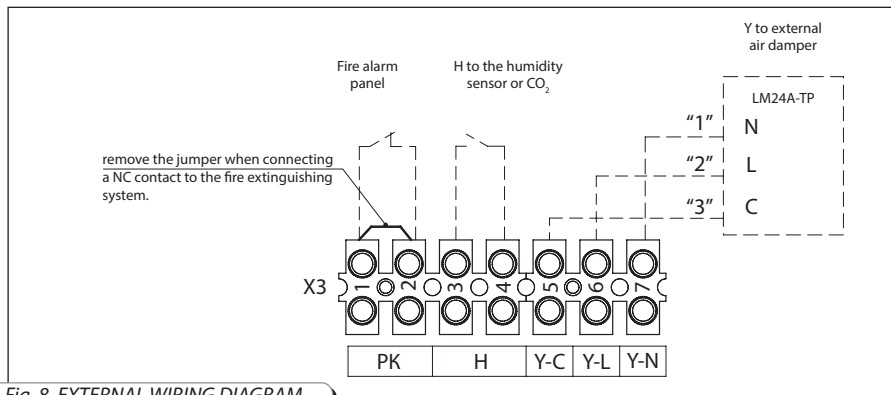

Fig. 8. EXTERNAL WIRING DIAGRAM

UNIT CONTROL

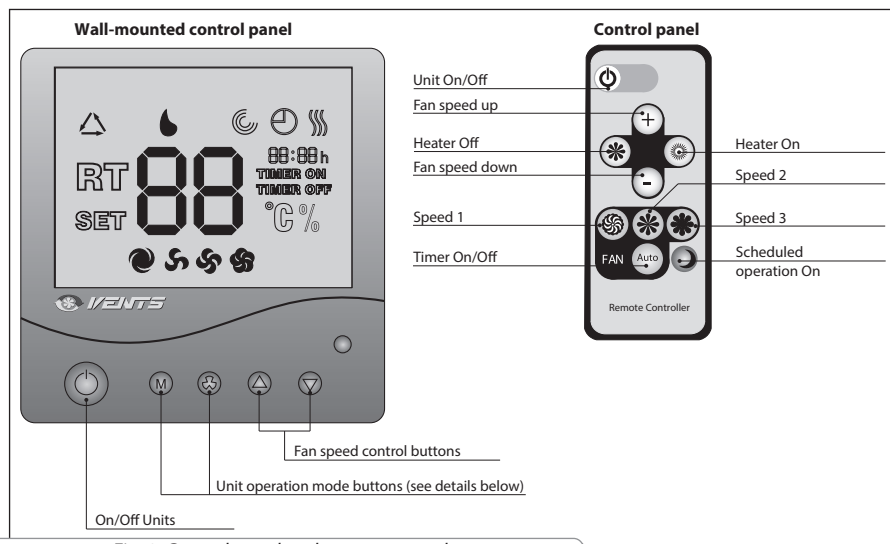

Fig. 9. Control panel and remote control

The unit is controlled from the wall-mounted control panel and the remote control, Fig. 9.

1. Unit On/Off

Unit activation/deactivation:

- by means of the Unit On/Off button  from the wall-mounted control panel;
- by means of the Unit On/Off button  from the remote control.

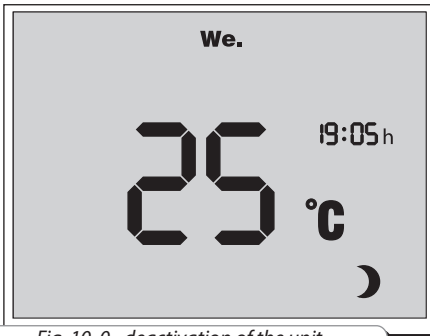

Fig. 10.0 - deactivation of the unit

When the unit is off (Fig. 10) the control panel display indicates:

- Room temperature
- Day of the week
- Time
- Off mode indication ☾;
- The **TIMER ON** and indicators glow in the Heater Cooling mode. Synchronously the heater cooling countdown is displayed in min: sec.

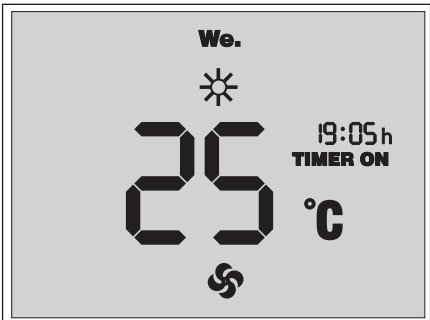

Fig. 11. Display readings while the unit is ON

When the unit is on (Fig. 11) the control panel display indicates:

- Room temperature
- Day of the week
- Time
- Fan speed status
- Timer status information

The **TIMER ON** indicator is on when the timer is enabled. The **TIMER OFF** indicator is on when the timer is disabled.

- Heater status information. The indicator is glowing when the heater is on.

2. Unit speed control

- From wall-mounted control panel: press the button to increase the speed or the button to reduce the unit speed (Speed 1 – Speed 2 – Speed 3)
- From the remote control: press to increase speed or to reduce speed (low speed – medium speed – high speed).
- From the remote control: press to set low speed, to set medium speed and to set high speed.

The screen of the wall-mounted control panel displays the current fan speed:

- indicator on: Speed 1;
- indicator on: Speed 2;
- indicator on: Speed 3.

3. Electric pre-heating of the supply air.

The supply air is warmed by the electric pre-heater to a pre-set temperature which is determined by the duct temperature sensor setpoint.

To turn on/off the supply air preheater automatically:

- To enable the electric pre-heater press and hold the button on the wall-mounted control panel and then press the button. The heater activation is confirmed by the indicator on the screen. To disable the heater press the button again.
- From the remote control unit: press the button to enable the heater and then press the button to disable it.









UPON DEACTIVATION OF THE UNIT WITH THE ELECTRIC HEATER ENABLED THE UNIT CONTINUES TO OPERATE FOR ANOTHER 2 MINUTES TO COOL DOWN THE HEATER. THE  SYMBOL IS DISPLAYED DURING THE HEATER COOLDOWN.

4. Timer.

The timer is designed to switch the fans to maximum speed with subsequent automatic reset to a previous speed after a set time period, from 20 to -60 minutes.

Turning the timer on/off:

- From the wall-mounted control panel: press and hold , then press  to turn the timer on. Press the button once to set the timer for 20 minutes, each subsequent pressing extends the timer setting for 10 minutes. The maximum timer setting is 60 minutes. Press and hold  for 3 seconds to turn the timer off.
- From the remote control: press  to turn the timer on for 20 minutes. To turn the timer off switch off the unit by pressing  or .

5. Heat exchanger freezing protection by supply air pre-heater.



- If the supply air temperature in the supply air duct upstream of the heat exchanger drops below the pre-set value (-10 °C by default) the pre-heater is automatically enabled to prevent heat exchanger freezing.
- If the pre-heater is unable to provide sufficient cooling at the maximum output and the air duct temperature upstream of the heat exchanger remains below the pre-set value for 10 minutes the unit drops the fan speed one step down.

6. Unit parameter settings.







CHANGING THE UNIT SETTINGS RESULTS IN LOSS OF THE FACTORY SETTINGS! FAN AND TEMPERATURE SENSOR SPEED ADJUSTMENT IS POSSIBLE ONLY FROM THE CONTROL PANEL!

Fan Speed Setting mode.

The unit operates at low, medium or high speed. During the unit setup the capacity of low, medium and high speed can be continuously adjusted. To enter the Fan Adjustment mode turn the unit off. Then press and hold  on the control panel and hold  pressed for 3 seconds.

Access to the Fan Capacity Adjustment mode is confirmed by the **SET** and **%** indicators on the control panel display.

- To select the required speed to be adjusted use  and .

When selecting the speed the selected speed is displayed by the indications ,  or .

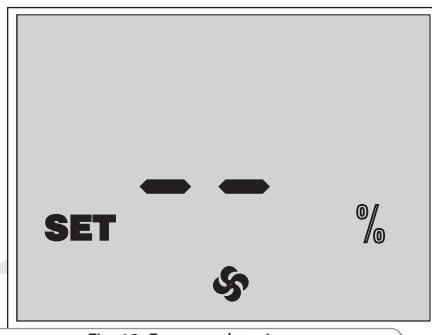

Fig. 12. Fan speed setting

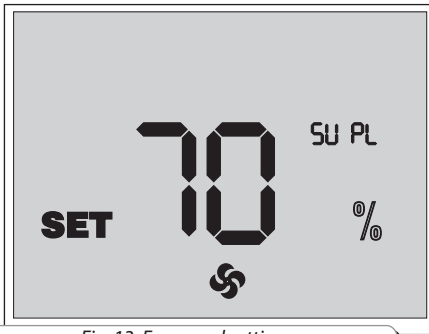















Fig. 13. Fan speed setting

- To adjust the supply fan capacity press and hold  and then press  to set the fan speed up or  to set it down. Each pressing of  and  increases or reduces the supply fan speed by 1%. If  is pressed the display indicators show the current supply fan speed (Fig. 13).

- To adjust the extract fan capacity press and hold . While holding  adjust the fan speed by pressing  for setting speed up and  for setting speed down. Each pressing of  and  increases or reduces the extract fan speed by 1%. If  is pressed the display indicators show the current extract fan speed.

To exit the Fan Speed Setting mode and save the changes press .

Fan speed adjustment is not possible with the remote control.

To restore factory settings enter the Fan Speed Setting mode, synchronously press and hold  and  for 3 seconds.

Fan speed factory settings:

Speed 1 – 40 %

Speed 2 – 70 %

Speed 3 – 100 %

Supply air duct temperature sensor adjustment mode.



To enter the supply air temperature duct sensor set-up mode disable the air handling unit and then press the  and the  buttons on the control panel simultaneously.



Fig. 14. Temperature sensor setup

The sensor set-up mode is confirmed by the **SET** and the **°C** indicators.

- The control panel screen displays the duct temperature sensor and the freezing protection sensor settings (see Fig. 14).

- Press the  button to set the duct sensor temperature. The temperature value is set incrementally in the range from +16 °C to +30 °C range in 2 °C steps.

- Press the  button to set the freezing protection sensor temperature. The temperature setpoint is selected in the range from -20 °C up to +10 °C.

- To view the current temperature sensor readings press and hold .

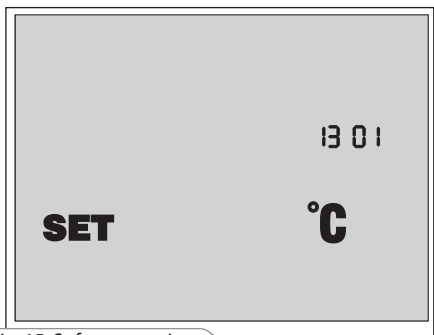

Fig. 15. Software version

- Press to view the controller board model code and software version code on the control panel display.
- To exit the Sensor Adjustment mode press .

7. Filter replacement indication.

After 3,000 machine hours the unit control panel screen changes from the operating temperature display to filter cleaning or change indication (Fig. 16).

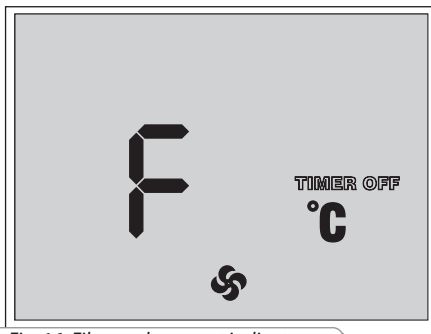

Fig. 16. Filter replacement indicator.

- When the filter replacement indicator **F** is active switch off the unit by pressing and disconnect it from power supply. Then replace the filters. List of possible alarms is show in the «Technical data» section on page 19.
- Then switch on the unit by pressing on the wall-mounted control panel or on the remote control. Then press and simultaneously to reset the hour meter.

8. Date/time setting.

- Turn the unit off.
- To enter the Date/Time Setting mode press and hold , then press on the wall-mounted control panel.
- While holding down select the parameter for adjustment by pressing and . The adjusted parameter is blinking.

The date/time setting parameters are arranged in the following order:

1. Minute
2. Hour
3. Day of the week
4. Date
5. Month
6. Year

- Set the desired value of the selected parameter by pressing and on the control panel.
- To exit Date/Time Setting mode press .

9. Scheduled Operation mode.

- Press and hold , then press on the control panel to activate the Scheduled Operation mode. The indicator lights up when the Scheduled Operation mode is activated.
- Press and hold , then press on the control panel to deactivate the Scheduled Operation mode.
- From the remote control the Scheduled Operation mode is activated/deactivated by pressing .
- Timer control has higher priority than scheduled operation.

10. Scheduled Operation mode setting.

Each day of the week has four entries. Time of switching the unit to the set speed and turning the heater on or off can be set for each entry.

- To enter the Scheduled Operation mode settings turn the unit off by pressing on the control panel or on the remote control.
- Press and hold on the control panel and the press .

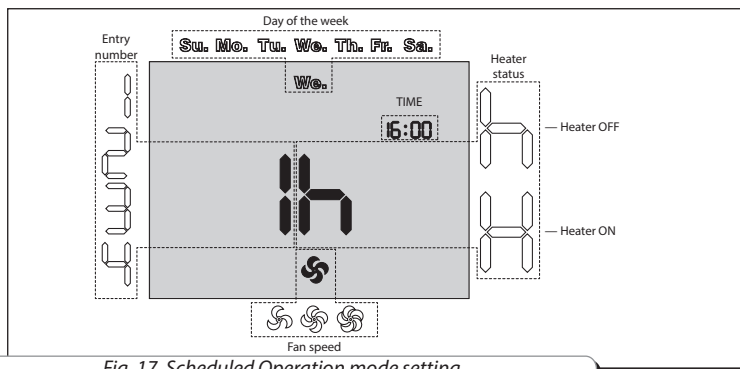

Fig. 17. Scheduled Operation mode setting.

- To select the scheduled operation parameters press and hold the button and then select and set the necessary parameter with the and buttons.
- Scheduled operation parameters:
 - Entry number – each day of the week has four entries
 - Day of the week – setting a day of the week
 - Heater status – setting the heater status for the current entry: **H** – heater on, **h** – heater off
 - Fan speed – setting the fan speed for the current entry.
 - Time – setting time for the current entry.
- To copy the set entries for the next day press and hold and press . No copying from Sunday to Monday is possible.
- Press on the control panel or on the remote control to exit the Scheduled Operation Setting mode.

Scheduled operation programming example is shown in the table. 3. By default, the Scheduled Operation mode is set for the warm seasons. When selecting this mode for the cold seasons set the heater status **H**.

Table 3. Programming example

Day of the week	Entry number											
	1			2			3			4		
	Start time	Mode	Heater status	Start time	Mode	Heater status	Start time	Mode	Heater status	Start time	Mode	Heater status
Mo.	07:00	medium speed	OFF	08:00	first speed	OFF	17:00	medium speed	OFF	22:00	first speed	OFF
Tu.	07:00	medium speed	OFF	08:00	first speed	OFF	17:00	medium speed	OFF	22:00	first speed	OFF
We.	07:00	medium speed	OFF	08:00	first speed	OFF	17:00	medium speed	OFF	22:00	first speed	OFF
Th.	07:00	medium speed	OFF	08:00	first speed	OFF	17:00	medium speed	OFF	22:00	first speed	OFF
Fr.	07:00	medium speed	OFF	08:00	first speed	OFF	17:00	medium speed	OFF	22:00	first speed	OFF
Sa.	10:00	medium speed	OFF	12:00	medium speed	OFF	17:00	medium speed	OFF	23:00	first speed	OFF
Su.	10:00	medium speed	OFF	12:00	medium speed	OFF	17:00	medium speed	OFF	23:00	first speed	OFF

11. Alarms.

In case of an emergency the air handling unit is disabled while the control panel screen displays the alarms (Fig. 18). The list of possible alarms is given in Table 4.

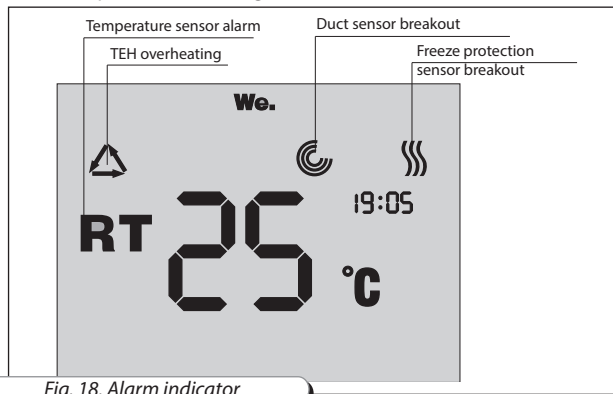





Fig. 18. Alarm indicator

Table 4. Air handling unit alarms

ALARM	INDICATOR	TROUBLESHOOTING
TEH overheating		TEH overheating. Contact the maintenance service.
Temperature sensor malfunction	RT	Shorting of one or two temperature sensors. Contact the maintenance service.
Supply air temperature duct sensor breakout	RT 	Contact the maintenance service to restore the supply air duct temperature sensor connection.
Freeze protection sensor breakout	RT 	Contact the maintenance service to restore the freezing protection sensor connection.

TECHNICAL MAINTENANCE

Maintenance operations of the unit are required 3–4 times per year. Maintenance includes general cleaning of the unit and the following operations:

1. Filter maintenance (3–4 times per year).

Clogged filters increase air resistance in the system and reduce supply air volume. The filters require cleaning not less than 3–4 times per year. Vacuum cleaning is allowed. After two cleanings filters must be replaced. For new filters contact the Seller.

The steps to remove the filters and the heat exchanger are as follows (refer to the figure below):

1. Undo the four triangular knobs.
2. Open the unit access door and undo two M6 screws to release the limiters.
Close the unit door and lift it off the carriers.
3. Remove the heat exchanger from the unit by pulling on the ribbon.
4. Remove the exhaust and supply filters.

The filters are installed in the reverse order.

2. Heat exchanger maintenance (once a year).

Some dust may accumulate on the heat exchanger block even in case of regular maintenance of the filters. To maintain the high heat recovery efficiency, regular cleaning is required. To clean the heat exchanger pull it out, flush the heat exchanger with warm detergent solution. After cleaning install the dry heat exchanger back to the unit.

3. Fan maintenance (once a year).

Please be aware that regular maintenance of the filters may not completely prevent gradual dust accumulation in the fans which causes a reduction in the unit performance and the amount of air supplied to the serviced space. Clean the fan with a dry cloth or a brush.

Do not use water, aggressive solvents or sharp objects as they may damage the impeller.

4. Condensate drain system maintenance (once per year).

The condensate drainage (drain line) may get clogged by dirt and dust particles contained in the exhaust air. Check the drain line operation by filling the drain pan under the unit with water, clean the U-trap and the drain line, if necessary.

5. Technical maintenance of the supply grille (twice a year).

The supply grille may get clogged with leaves and other objects which may reduce the unit performance. Check the supply grille twice a year and clean it if necessary.

6. Technical maintenance of air duct system (every 5 years).

Please be aware that even regular performance of the above maintenance steps may not completely prevent dust from penetrating the air ducts which causes a reduction in the unit performance. Duct maintenance means regular cleaning or replacement.

7. Control unit maintenance (if necessary).

The control unit maintenance must be performed by an expert qualified for unassisted operations with electrical installations with the voltage up to 1000 V after careful reading of the user's manual. Prior to performing control unit maintenance disconnect the air handling unit from the electric mains.

Control unit access (Fig. 20):

1. Open the unit door and remove the heat exchanger.
2. Undo the self-tapping screws and remove the protective cover.
3. Undo the fastening screws of the swing-down control unit panel while holding the tilting panel by hand.
4. Lower the swing-down panel.

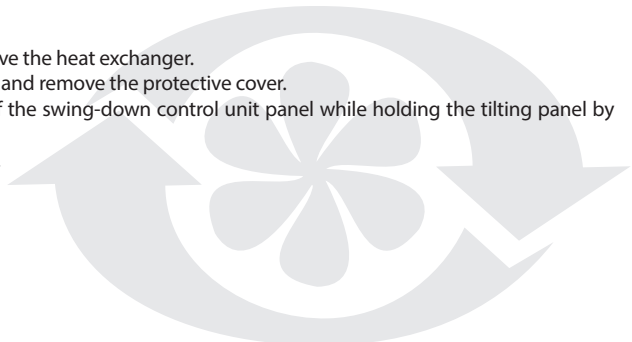

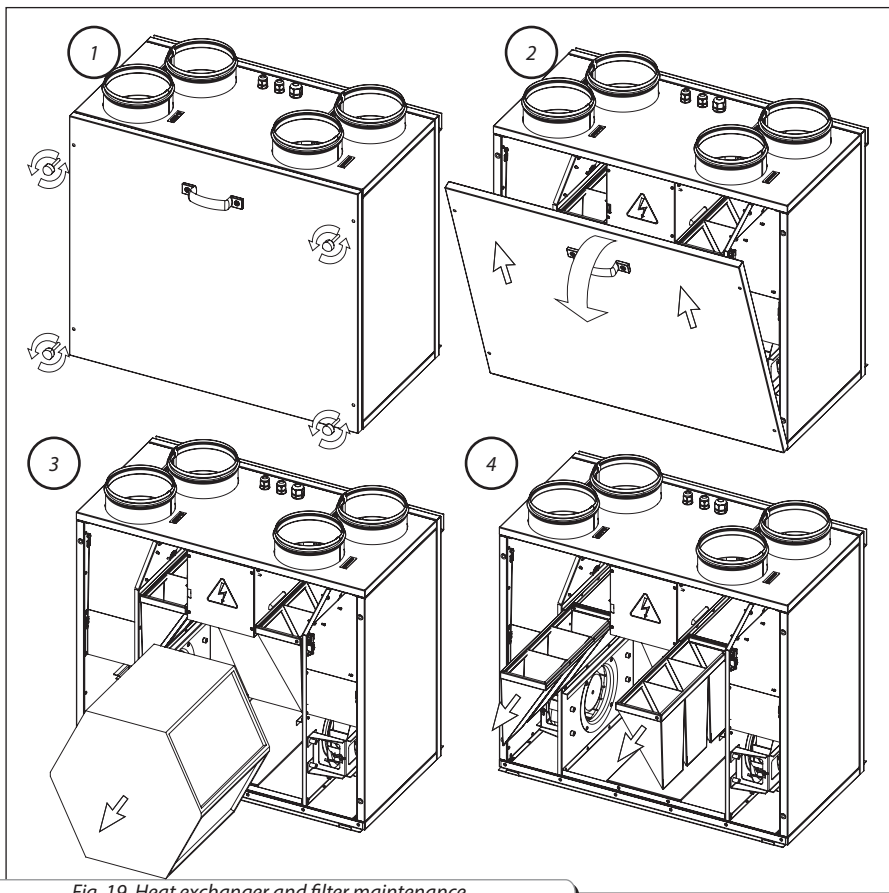

Fig. 19. Heat exchanger and filter maintenance.



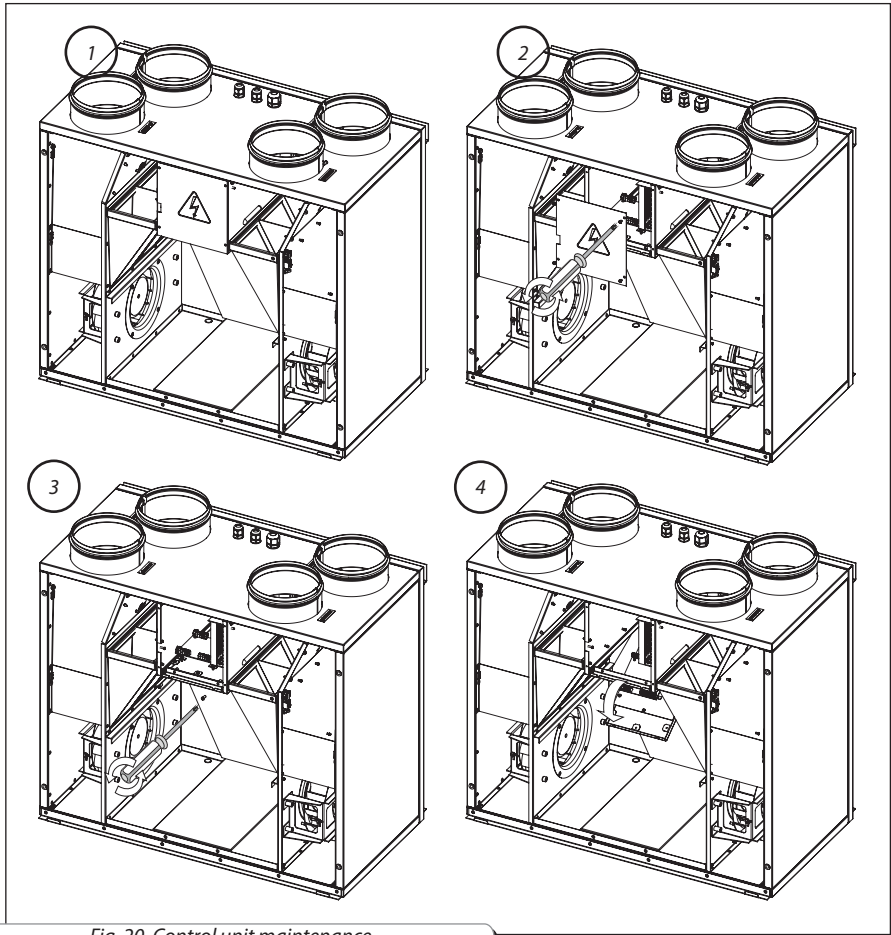

Fig. 20. Control unit maintenance.



TROUBLESHOOTING

Possible faults and troubleshooting

Problem	Possible reasons	Elimination method
The fan(s) do(es) not start	No power supply.	Make sure that the unit is properly connected to the electric mains and make any corrections, if necessary.
Cold supply air	Extract filter clogging.	Clean or replace the extract filter.
	Heat exchanger freezing.	Check the heat exchanger for ice. If necessary, stop the unit and let the ice melt.
Low air flow	The filters, the fans or the heat exchanger is clogged.	Clean or replace the filters; clean the fans and the heat exchanger.
	The ventilation system is clogged or damaged.	Check the diffusers and louvres for proper opening, check the exhaust hood and the supply intake grill and clean them, if necessary. Make sure that the air ducts are free from contamination and damage.
Noise, vibration	Contaminated fan impellers.	Clean the impellers.
	The screw connection is loose.	Tighten the fastening screws.
Water leakage	Drain pipe clogged, damaged or improperly installed.	If necessary, clean the drain line. Check the drain pipe slant angle and the U-trap. Make sure that the drainage system freezing protection is in place.

STORAGE AND TRANSPORTATION REGULATIONS

The unit must be stored in the original packing in a dry ventilated area at temperatures from -10°C to $+40^{\circ}\text{C}$.

Storage environment must not contain aggressive vapours and chemical mixtures provoking corrosion, insulation and sealing deformation.

Use hoist machinery for handling and transportation to prevent possible mechanical damages of the unit.

Follow the handling requirements applicable for the particular type of cargo.

The unit can be transported in the original packing by any mode of transport without limitation provided proper protection against precipitation and mechanical damage.

Avoid sharp blows, scratches or rough handling during loading and unloading.

MANUFACTURER'S WARRANTY

The manufacturer hereby warrants normal operation of the unit over the period of 24 months from the retail sale date provided observance of the transportation, storage, installation and operation regulations. Should any malfunctions occur in the course of the unit operation through the Manufacturer's fault during the guaranteed period of operation the user is entitled to elimination of faults by the manufacturer by means of warranty repair at the factory carried out free of charge.

The warranty repair includes work specific to elimination of faults in the unit operation to ensure its intended use by the user within the warranty period.

The faults are eliminated by means of replacement or repair of the complete unit or the faulty part thereof.

The warranty repair does not include:

- routine technical maintenance
- unit installation / dismantling
- unit setup

To benefit from warranty repair the user must submit the unit, the User's Manual with the sale date stamp and the payment document certifying the purchase.

The unit model must comply with the one stated in the user's manual.

Contact the Seller for warranty service.

The manufacturer's warranty does not apply to the following cases:

- user's failure to provide the unit with the entire delivery package as stated in the user's manual or with missing component parts previously dismantled by the user
- mismatch of the unit model and make with the respective details stated on the unit packing and in the user's manual
- user's failure to ensure timely technical maintenance of the unit
- external damage to the casing (excluding external modifications of the unit as required for its installation) and the internal components of the unit
- alteration of the unit design or engineering changes of the unit
- replacement and use of the unit assemblies, parts and components not approved by the manufacturer;
- unit misuse
- user's violation of the unit installation regulations
- user's violation of the unit management regulations
- unit connection to the power mains with a voltage different from the one stated in the user's manual
- unit breakdown due to voltage surges in the power mains
- user's discretionary repair of the unit
- unit repair performed by any persons not authorized by the manufacturer
- expiry of the unit warranty period
- user's violation of the established regulations specific to the unit transportation
- user's violation of the unit storage regulations
- wrongful acts against the unit committed by third persons
- unit breakdown due to circumstances of insuperable force (fire, flood, earthquake, war, hostilities of any kind, or blockade)
- missing seals if provided by the user's manual
- failure to submit the user's manual with the unit purchase date stamp
- missing payment document certifying the unit purchase



FOLLOWING THE REGULATIONS STIPULATED HEREIN WILL ENSURE A LONG AND TROUBLE-FREE OPERATION OF THE UNIT.



USERS' CLAIMS SHALL BE REVIEWED ONLY UPON PRESENTATION OF THE UNIT, THE PAYMENT DOCUMENT AND THE USER'S MANUAL WITH THE SALE DATE STAMP.

ACCEPTANCE CERTIFICATE

Unit Type	Air handling unit with heat recovery
Model	VUT 300 ___ E2V EC
Serial Number	
Manufacture Date	
Meets the technical specifications as stated in TU U 28.2-30637114-018:2013 and is hereby declared ready for service.	
Quality Inspector's Stamp	

SELLER INFORMATION

Seller	
Address	
Phone Number	
E-mail	
Purchase Date	

This is to certify delivery of the complete the unit with the User's Manual. The warranty terms are acknowledged and accepted.

Customer's Signature

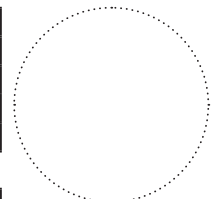

Seller's Stamp

CONNECTION CERTIFICATE

VUT 300 ___ E2V EC air handling unit with heat recovery has been installed and connected to the electric mains in accordance with the requirements of this User's Manual.

Company Name	
Address	
Phone Number	
Installation technician's full name	
Installation Date:	Signature:

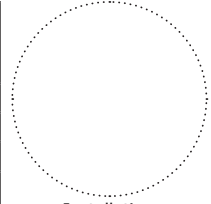

Installation
Company Stamp

The unit has been installed in accordance with the provisions of all the applicable local and national construction, electrical and technical codes and standards. The unit operates normally as intended by the manufacturer.

Signature:

WARRANTY CARD

Unit Type	Air handling unit with heat recovery
Model	VUT 300 ___ E2V EC
Serial Number	
Manufacture Date	
Purchase Date	
Warranty Period	
Seller	

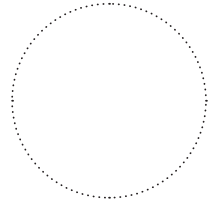

Seller's Stamp

NOTES



