

# OPERATION MANUAL

## Air Supply and Exhaust Unit

VUT 350 U EC  
VUT 350 EU EC



**CONTENTS**

Introduction	3
Purpose	3
Delivery Package	3
Designation key	4
Main Technical Specifications	4
Safety Requirements	6
Design and Operating Logic	6
Installation and Setup	7
Condensate Drainage	9
Connection to Power Mains	10
Unit Control	11
Technical Maintenance	18
Fault Handling	20
Storage and Transportation Regulations	21
Manufacturer's Warranty	21
Acceptance Certificate	22
Connection Certificate	22
Warranty Card	22



## INTRODUCTION

The present operation manual consisting of the technical details, operating instructions and technical specification covers the installation of the VUT 350 (E)U EC air handling unit with heat recovery of VENTS series (hereinafter the Unit).

## PURPOSE

The unit is designed to ensure continuous mechanical air exchange in houses, offices, hotels, cafés, conference halls, and other utility and public spaces as well as to recover the heat energy contained in the air extracted from the premises to warm up the filtered stream of supply air.

The unit is not intended for organizing ventilation in swimming pools, saunas, greenhouses, summer gardens, and other spaces with high humidity.

Due to the ability to save heating energy by means of energy recovery, the unit is an important element of energy-efficient premises.

The unit is a component part and is not designed for stand-alone operation.

It is rated for continuous operation.

Transported air must not contain any flammable or explosive mixtures, evaporation of chemicals, sticky substances, fibrous materials, coarse dust, soot and oil particles or environments favourable for the formation of hazardous substances (toxic substances, dust, pathogenic germs).

Relative humidity of transported air must not exceed 80 % at an ambient temperature of +20 °C.



**The unit is not intended for operation by children or any persons with reduced physical, mental or sensory capacities as well persons lacking the required training. The unit must be handled only by properly qualified personnel after the appropriate safety instructions. Install the unit to be out of reach of children.**

## DELIVERY PACKAGE

- Unit - 1 item;
- Operation Manual - 1 item;
- Wall-Mounted Control Panel - 1 item;
- Remote Control - 1 item;
- Duct temperature sensor (VUT 350 EU EC only) - 1 item;
- Shipping Box - 1 item;
- Fixture Kit - 1 item.



## DESIGNATION KEY

# VUT 350 E U EC

**Motor Type**

Electronically Commutated

**Spigot Arrangement**

U – angular (versatile)

**Electric heater****Air capacity, m<sup>3</sup>/h****Unit type**

VUT - heat recovery ventilation

## MAIN TECHNICAL DATA

The unit is designed for operation in an enclosed area at ambient temperatures from +1 °C to +40 °C at relative humidity of up to 80%.

In order to prevent condensation on the internal walls of the units, it is necessary that the surface temperature of the casing is 2-3 °C higher than the dew point temperature of the transported air.

Hazardous parts access and water ingress protection standard:

- Unit motors - IP 44;
- Unit assembly connected to air ducts - IP 22.

The unit series designations, their main outside and connecting dimensions, appearance and technical parameters are given on Figure 1 and in Table 1.

The units undergo continuous improvement - therefore, some models may slightly differ from the ones described herein.

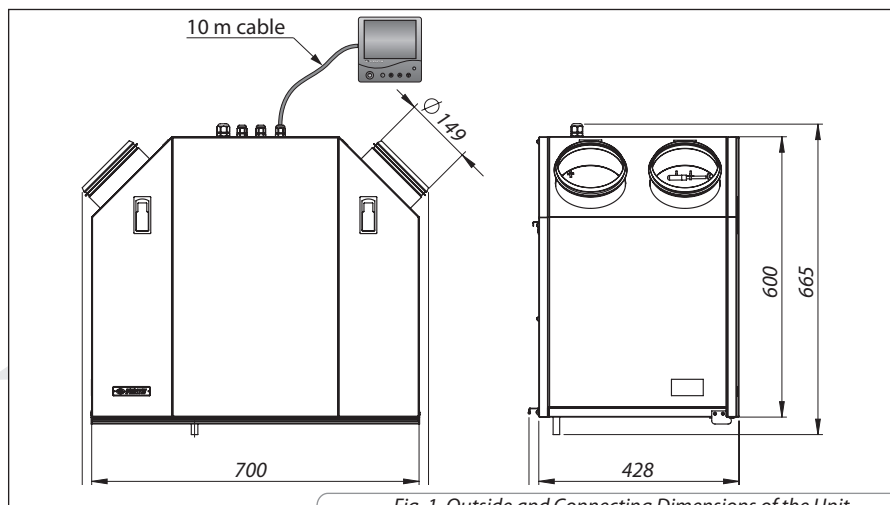

Fig. 1. Outside and Connecting Dimensions of the Unit

**Table 1 . Technical Parameters**

Model	VUT 350 U EC / VUT 350 EU EC		
Ventilation Mode	Speed 1	Speed 2	Speed 3
Supply Voltage, V/50/60 Hz	1 ~ 230		
Maximum Fan Power, W	36	138	220
Fan Current, A	0,29	0,97	1,48
*Electric Heater Power, kW	No / 2,0*		
*Electric Heater Current, A	no / 8,7*		
Total Unit Power, kW	0,22 / 2,22*		
Unit Maximum Consumption Current, A	1,5 / 10,0*		
Maximum Air Capacity, m <sup>3</sup> /h	133	270	331
RPM, min <sup>-1</sup>	1440	2200	2900
Sound Pressure Level at 3m, dB(A)	28	34	41
Transported Air Temperature, °C	from - 25 to +40		
Casing Material	Polymer Coated Steel		
Insulation	20 mm, mineral wool		
Filter: Air Exhaust/Air Supply	G4		
Connected Air Duct Diameter, mm	Ø 150		
Weight, kg	43 / 44*		
Recuperating Efficiency	up to 98%		
Heat Exchanger Type	Counterflow		
Heat Exchanger Material	Polystyrene		

\* - only applies to VUT 350 EU EC units

**Table 2 . Control Panel Specifications**

Ambient Temperature	from 0 °C to 40 °C
Relative Humidity	from 5% to 90 % (without condensation)
Cable Section, mm <sup>2</sup>	from 0.18 to 0.35
Material	ABS Plastic
Dimensions (WxHxD), mm	86x86x14
Cable Length, m	Up to 10
Protection Class	IP30



## SAFETY REQUIREMENTS

Installation and operation of the unit shall be subject to the present Operation Manual and the all applicable local building, fire safety, technical and electric regulatory documents.

The unit must be properly earthed.

Prior to connecting the unit to the power mains check for visible damage as well as for any foreign objects in the fan casing which may damage the impeller blades. If necessary, contact the service centre.



### ATTENTION!

**Make sure to disconnect the unit from the power mains prior to any installation, maintenance, connection and repair work.**



### RESTRICTIONS:

- **Do not operate the unit outside the permissible temperature range specified in the Operation Manual or in areas with aggressive admixtures in the air and in explosive environments.**
- **Do not connect drying machines or other similar high-power equipment to the ventilation circuit.**
- **Do not use the unit for handling air-dust mixtures.**

## DESIGN AND OPERATING PRINCIPLE

The unit design and operating principle are shown on Fig. 2. The warm stale air from the premises is supplied to the device and purified in the exhaust filter, passed through the heat exchanger and then extracted outside via the ducts by the exhaust fan. The cool fresh air from the outside enters the unit through the air ducts and is stripped of impurities in the supply filter.

The air then passes through the heat exchanger and is delivered into the premises by the supply fan. The heat exchanger ensures transfer of the heat energy extracted from the warm exhaust air to the clean outdoor air therefore heating it up.

The air streams do not get mixed in the heat recovery process. The use of a heat exchanger reduces heat energy losses and, consequently, the heating costs in the cold season.

The VUT 350 EU EC unit is equipped with a 2 kW electric heater with overheating protection which heats up the supply air. However, supply air heating is not available in the «Night» mode.

The unit design and operating principle are shown on Fig. 2.

The basic configuration includes:

1. Exhaust fan;
2. Supply Fan;
3. Counter-flow heat exchanger;
4. Exhaust air, filtering class G4;
5. Supply air, filtering class G4;
6. Condensate drain pan;
7. Condensate drain tubes;
8. Control Unit;
9. Bypass;
10. Bypass control temperature sensor;
11. Electric heater (only for VUT 350 EU EC unit);
12. Supply air duct temperature sensor.

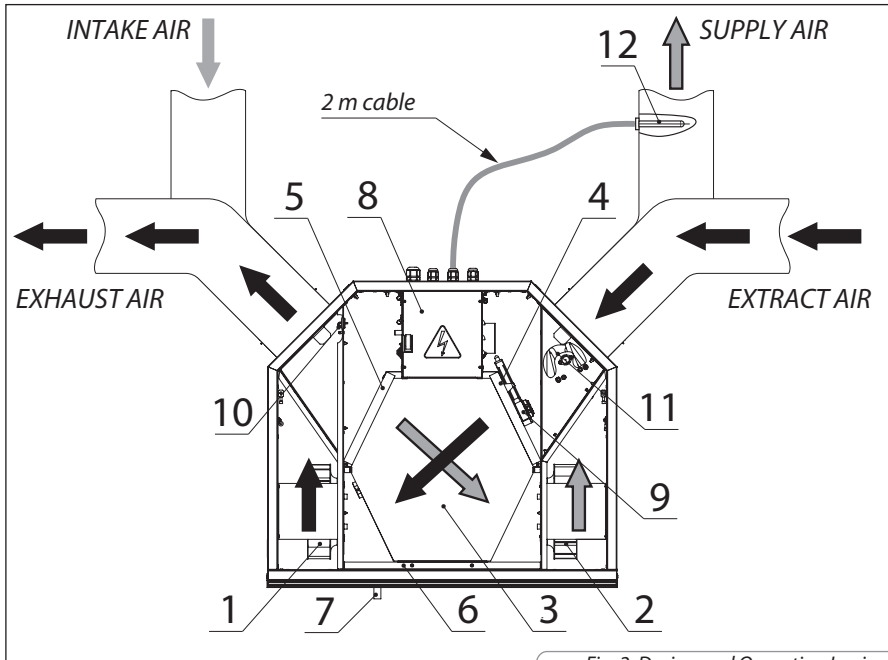

Fig. 2. Design and Operating Logic

## INSTALLATION AND SETUP

While installing the unit ensure convenient access for subsequent maintenance or repair.

The wall intended for unit installation must be smooth. Any surface irregularities will lead to unit casing skew and may prevent the unit from operating properly.

The unit installation is shown on Fig. 3:

- Secure the wall mount with anchor bolts at the necessary level (all the fasteners are included in the delivery package).
- Hang the unit onto the wall mount.

To ensure correct supply air pre-heating (only applicable to the VUT 350 EU EC) install the duct sensor into the air duct (item 12 on Fig. 2) at the minimum distance of 1 m from the supply spigot.

The installation steps for the supply air temperature duct sensor is as follows:

- drill a  $\varnothing 9$  mm hole in the air duct;
- insert the sensor into the hole;
- secure the sensor on site.

It is recommended that the sensor and air duct joint is hermetically sealed.

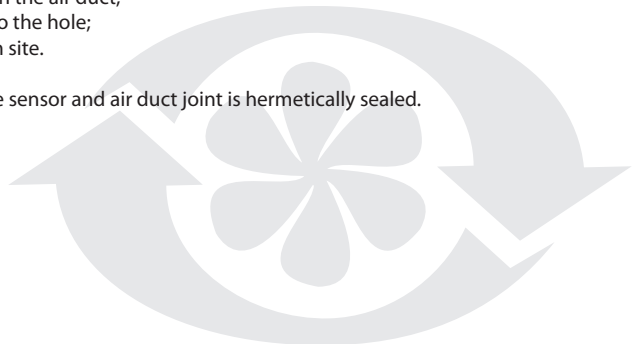

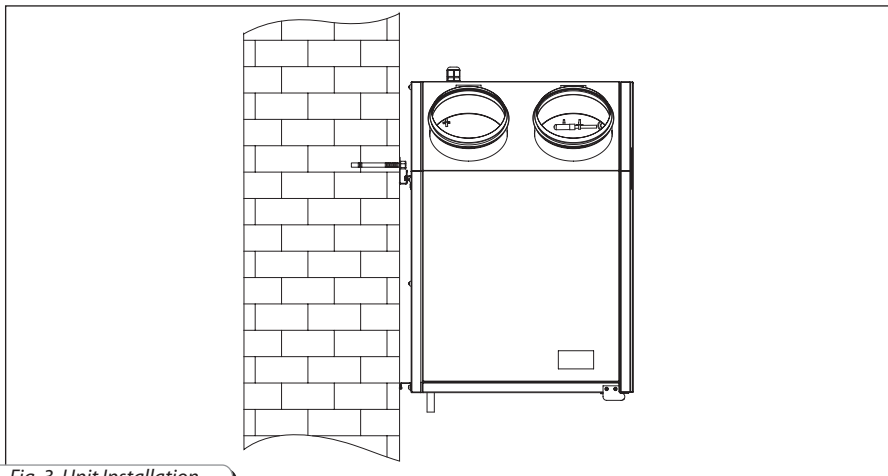

Fig. 3. Unit Installation

The wall-mounted control panel is installed as follows:

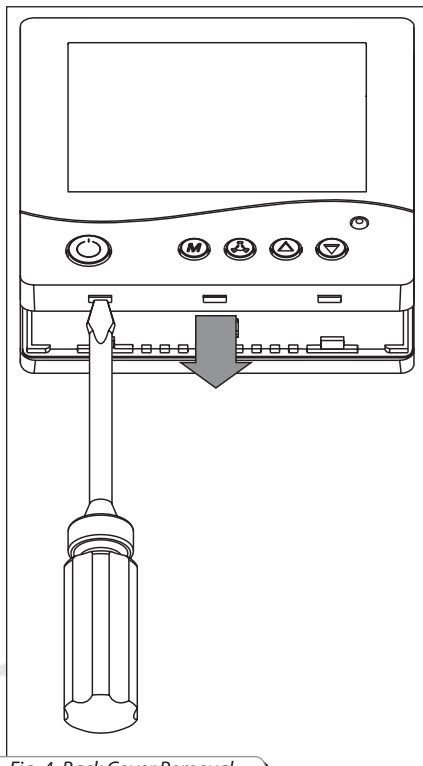

Fig. 4. Back Cover Removal

- Undo the clips through the access holes in the bottom of the wall-mounted control panel (Fig. 4).
- Remove the back cover.
- Disconnect the panel from the terminal block.
- Lay the cable in the wall to the panel installation site.
- Secure the panel back cover to the wall (Fig. 5).
- Fasten the cable to the terminal block.
- Clip the wall-mounted front panel in place.



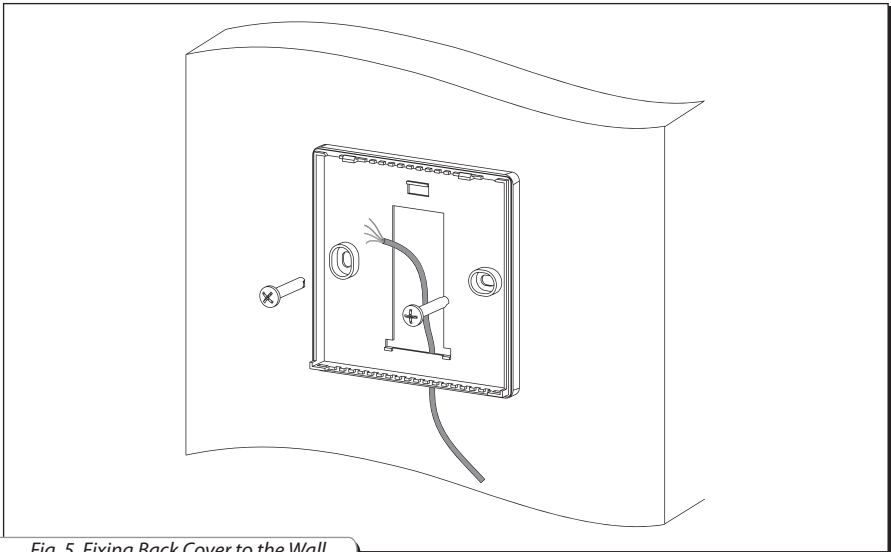

Fig. 5. Fixing Back Cover to the Wall

### CONDENSATE REMOVAL

The condensate drain pan installed in the heat recovery section has pipes for removing the condensed fluid outside the unit.

Connect the tube, the U-trap (not included in delivery package) and the sewage collection system with metal or rubber pipes (Fig. 6). The pipe pitch must be at least  $3^\circ$ . Fill up the system with water before connecting the unit to the power mains! During the operation the U-trap must be always filled with water. Make sure that the water flows freely into the sewage collection system or otherwise condensed water may build up in the unit during heat recovery, which consequently, may cause equipment failure and water ingress into the premises.

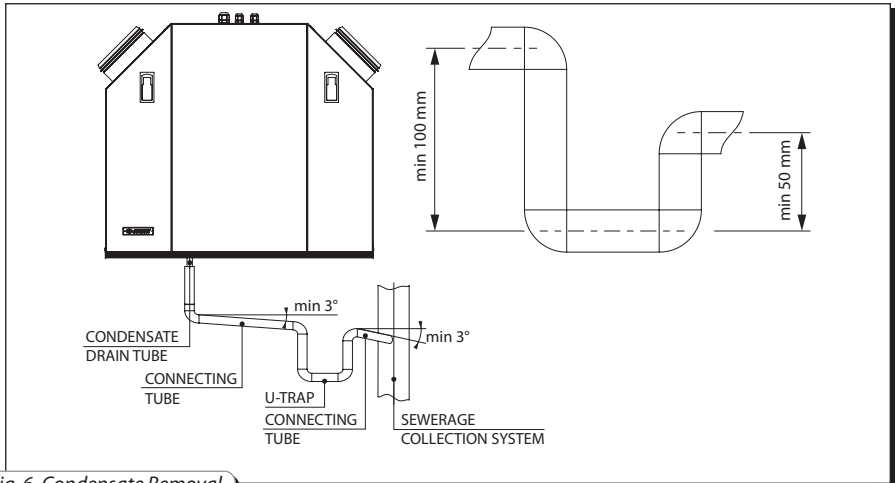

Fig. 6. Condensate Removal

The condensate drainage system is designed for indoor operation at ambient temperatures above 0 °C. If the expected air temperatures are below 0 °C, the condensate removal system must be equipped with heat insulation and pre-heating facilities.

## POWER MAINS CONNECTION



**Disconnect the unit from the power supply prior to any work. The unit must be plugged into a properly installed power socket with an earthed terminal. The nominal electrical parameters of the unit are given on the manufacturer's label. Any tampering with the internal connections is prohibited and will void the warranty.**

The unit is designed for connection to 230 V / 50 / 60 Hz single-phase AC power mains using the pre-wired power cord with a Euro plug.

The unit must be connected to the power mains via an automatic cutout switch built into the stationary wiring with a magnetic breaker with the nominal trip current at least equal to the unit consumption current (see Table. 1).

The unit enables the following external connection options (X3 connector markings as shown on the label are given in round brackets, Fig. 7):

Automatic fire extinguishing system contact («PK»);

Humidity relay (humidity sensor) contact or CO<sub>2</sub> sensor contact («H»);

«3-point control» air damper («Y-N, Y-L, Y-C»).

On connecting the automatic fire extinguishing system contact remove the jumper between terminals X3:1 and X3:2 of the terminal block X3; In this case a normally closed «dry» contact is used which opens the unit control circuit on fire-triggered actuation from the central fire-fighting station cutting the unit power.

The humidity sensor (or CO<sub>2</sub> sensor) connects to terminals X3:3 and X3:4 of the terminal block X3; The connection relies on a normally closed «dry» contact. Once closed the unit switches to maximum speed.

The damper actuator is connected to the terminals X3:5, X3:6 and X3:7 of the terminal block X3. The same contacts can be used for parallel connection of one more damper.

The additional contacts are connected according to the wiring connection diagram (Fig. 7). The wires are routed into the terminal box through a sealed lead-in on the top of the unit.

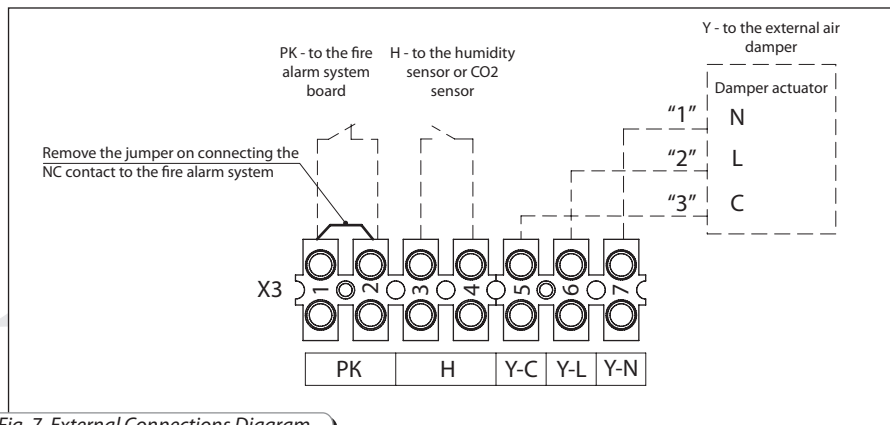
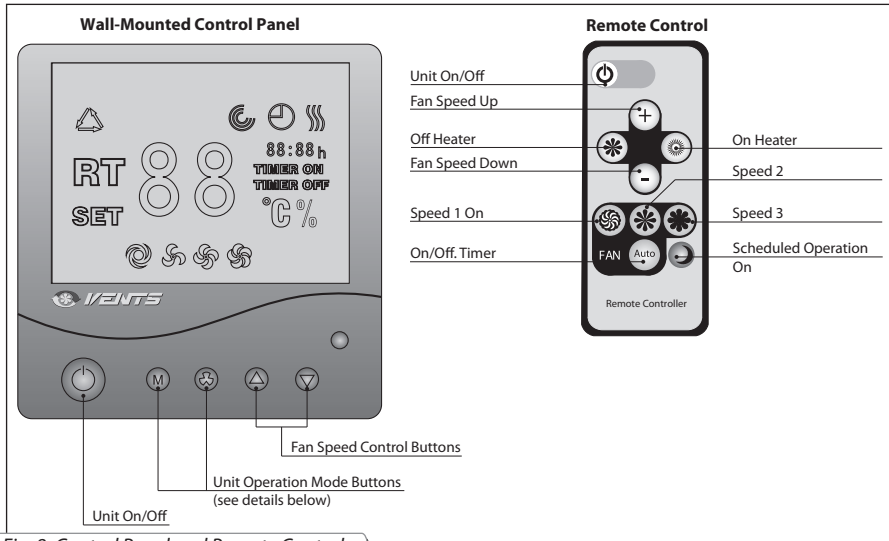

Fig. 7. External Connections Diagram

**UNIT CONTROL**

**Fig. 8. Control Panel and Remote Control**

The unit is controlled by means of the wall-mounted control panel and the remote control (Fig. 8).

**1. Unit ON \ OFF.**

The unit is activated \ deactivated:

- From the wall-mounted control panel by the Unit On/Off button ;
- From the remote control panel by means of the Unit On/Off button .

When the unit is off (Fig. 9) the wall-mounted control panel display indicates:

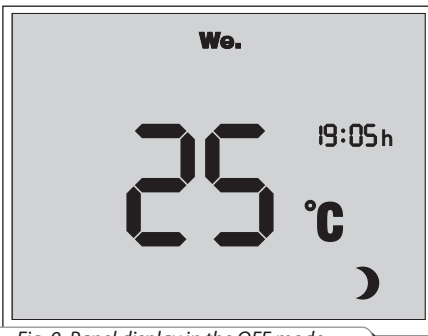
**Fig. 9. Panel display in the OFF mode**

- Room temperature;
- Day;
- Time;
- Deactivated status ;
- In the TEH blowing mode indicators **TIMER ON** and (blowing) are on as well as the blowing countdown (minutes : seconds) (only applies to the VUT 350 EU EC).

When the unit is on (Fig. 10) the wall-mounted control panel display indicates:

- Room temperature;
- Day;
- Time;
- Fan speed status
- Timer status;

Timer operation is confirmed by the **TIMER ON** indicator.

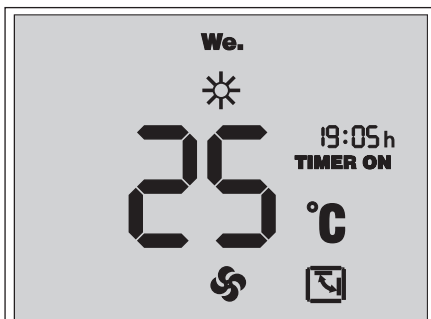

Fig. 10. Display in the ON state

## 2. Ventilation Mode Control.

The ventilation modes of the unit are selected:

- From the wall-mounted control panel: Press the button to increase the speed or press the button to reduce the speed cyclically (i.e. speed 1 - speed 2 - speed 3).
- From the remote control: Press the button to increase the speed or press the button to reduce the speed cyclically (i.e. speed 1 - speed 2 - speed);
- From the remote control: Press the button to select speed 1, press the button to select speed 2 or press the button to select speed 3 correspondingly.

The wall-mounted control panel display shows the current fan speed status:

- Indicator — «Speed 1» mode»;
- Indicator — «Speed 2» mode»;
- Indicator — «Speed 3» mode».

## 3. Supply Air Pre-Heating (only applicable to the VUT 350 EU EC unit).

The supply air pre-heater raises the temperature to the pre-set value depending on the duct temperature sensor setting. The heater is activated / deactivated:

- From the wall-mounted control panel: press and hold the button, then press the button.
- From the remote control: to switch the heater on press the button, or press the button to switch it off.



### ATTENTION!

Upon deactivation with a working heater the unit continues operation for an additional 2 minutes to allow heater cooling. This is confirmed by indicator .

## 4. Timer.

The timer enables automatic switching of the fans to the maximum speed with automatic reversion after a selected period of time (20-60 minutes). The timer is activated / deactivated:

- From the wall-mounted control panel: To activate the timer press and hold the button and then press the button. A single press of the button sets the timer to 20 minutes while each subsequent press increases the timer setting in 10 minute increments. The maximum timer setting is 60 minutes. To deactivate the timer press and hold the button for 3 seconds;
- From the remote control: To activate the timer for a 20 minute interval press the button. The timer can only be set for 20 minutes. to deactivate the timer switch the unit off by means of the button or the button.

When the timer is off, the indicator **TIMER OFF** goes on.

- Heater status information. Heater operation is confirmed by the indicator (only applies to the VUT 350 EU EC).
- Open bypass damper is confirmed by the indicator on the display screen.

### 5. Frost Protection.

- **VUT 350 EU EC:** At air temperature in the supply duct upstream of the heat Exchanger in the range from -7 °C to -15 °C the bypass switches to the automatic regulation cycle (5 minutes in the open position then 25 minutes in the closed position). At air temperatures below -15 °C the bypass opens for 5 minutes and then closes for 15 minutes.

- **VUT 350 UEC:** The bypass fan switches off on air temperature in the exhaust duct downstream of the heat Exchanger dropping below +3 °C. When the air temperature raises above the +3 °C threshold the unit reverts to normal operation.

- The bypass damper can be opened or closed manually. While holding the button, press the button and check that the indicator appears. This function may be necessary when recuperation is not required (e.g. when the outdoor temperature is identical or nearly equal to the indoor temperature). The bypass position is saved in the memory even after the unit deactivation and reactivation.

### 6. Unit Parameter Setup Mode.



**Changing ventilation mode performance settings will alter the fan power settings made at the factory! Fan speed and temperature sensor setup is only possible by means of the wall-mounted control panel!**

#### Fan Speed Setup Mode.

Ventilation performance settings are made in the fan speed setup mode. The fan speed setup mode is only available while the unit is off. To access the fan speed setup mode press and hold the button on the wall-mounted control panel, and then press and hold the button for 3 seconds.

Upon entering the setup mode the wall-mounted panel display screen will show the **SET** and **%** indicators (Fig. 11).

- Set the fan speed as necessary using the and buttons.

While the speed is being set the display screen will show the currently selected speed or .

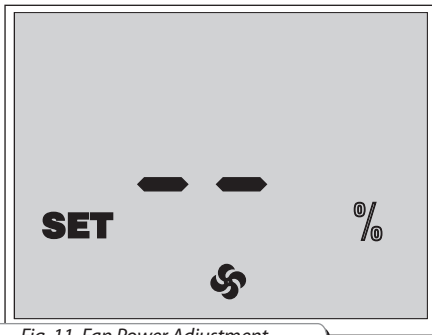

Fig. 11. Fan Power Adjustment

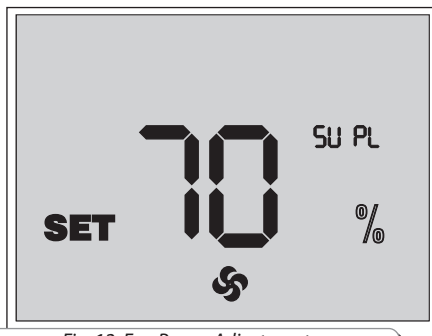









Fig. 12. Fan Power Adjustment

- To change the supply fan power press and hold the button and press the button to increase the speed or press the button to decrease it. Each press of the and buttons increases or decreases the supply fan power in 1 % increments. With the button pressed the display screen will indicate the current supply fan power (Fig. 12).

- To change the exhaust fan power press and hold the button.

Adjust the fan power by using the  button to increase it and the  button to decrease it. Each press of the  and  buttons increases or decreases the exhaust fan power in 1 % increments. With the  button pressed the display screen will indicate the current exhaust fan power.

To exit the fan speed setup mode and save the changes press the  button.  
The remote control cannot be used to change ventilation mode parameters.

To revert to the factory settings, enter the fan speed setup mode and press the  and  buttons simultaneously and hold them for 3 seconds.



Factory fan speed settings:

Speed 1 — 40 %

Speed 2 — 70 %

Speed 3 — 100 %

### Duct Temperature Sensor Setup Mode (only applicable to the VUT 350 EU EC unit).

To enter the duct temperature sensor setup mode switch off the unit and simultaneously press the  and  buttons on the wall-mounted control panel.

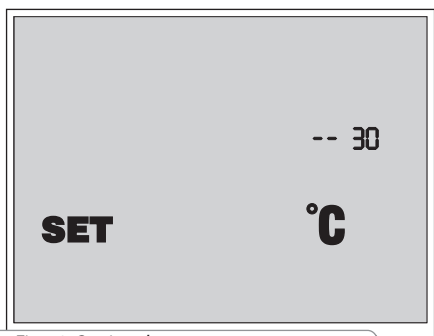



Fig. 13. Setting the temperature sensors

Entering the sensor setup mode is confirmed by the **SET** and **°C** indicators.

- While in the setup mode the wall-mounted control panel screen displays the duct temperature sensor settings (Fig. 13).

- The duct temperature sensor setting is adjusted by pressing the  button. The values are cycled in the range from +16 °C to +30 °C in 2 °C increments.

- To view the current temperature sensor settings press the  button.

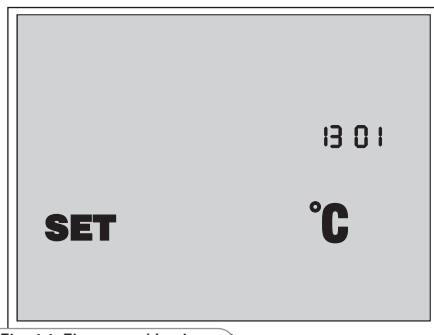



Fig. 14. Firmware Version

- Press the  button to display the controller circuit execution code and the firmware version code on the wall-mounted control panel screen (Fig. 14).

- To exit the duct temperature sensor setup mode press the  button.

### 5. Filter Replacement Signal.

On elapsing of the filter replacement interval (3 000 hours) the temperature indication on the wall-mounted control panel display screen will be substituted by the **F** filter replacement alert (Fig. 16).

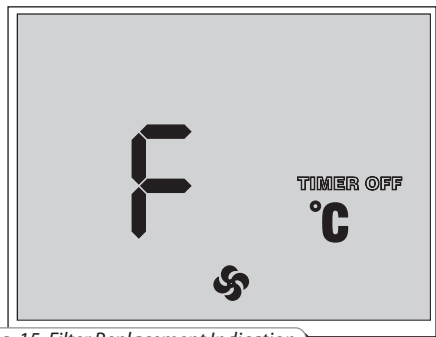











Fig. 15. Filter Replacement Indication

- On filter replacement indications switch off the unit by pressing the  button and disconnect it from the power mains. Replace the filter (see the sequence given in the «Technical Maintenance» section, page 19).



- Switch on the unit by pressing the  button on the wall-mounted panel or the  button on the remote control. Then press the  and  buttons to reset the service hour counter.

### 6. Date and Time Setup.







- Switch off the unit.
- To enter the date and time setup mode press and hold the , then press the  button on the wall-mounted control panel.
- While holding the  button select the parameter for adjustment by using the  and  buttons. The parameter being adjusted is highlighted by blinking.

The date and time parameters are ordered as follows:

1. Minutes;
2. Hours;
3. Day;
4. Date;
5. Month;
6. Year.





- Use the  and  buttons on the wall-mounted control panel to change the selected parameter setting as necessary.
- To exit the date and time setup mode press the .

### 7. Scheduled Operation Mode.

- To activate the scheduled operation mode press and hold the , and then press the  button on the wall-mounted control panel. The scheduled operation mode is confirmed by the  indicator on the display screen.
- To deactivate the scheduled operation mode press and hold the , and then press the  button on the wall-mounted control panel.
- You can also activate or deactivate the scheduled operation mode by using the  button on the remote control.
- The timer will always prevail over scheduled operation.

### 8. Scheduled Operation Setup.

There are four entries for each day which contain the time for unit switching to a specific fan speed as well as heater activation or deactivation.

- To access the scheduled operation settings switch off the unit by pressing the  on the wall-mounted control panel or the  button on the remote control.
- Press and hold the  button on the wall-mounted control panel, and then press the  button.

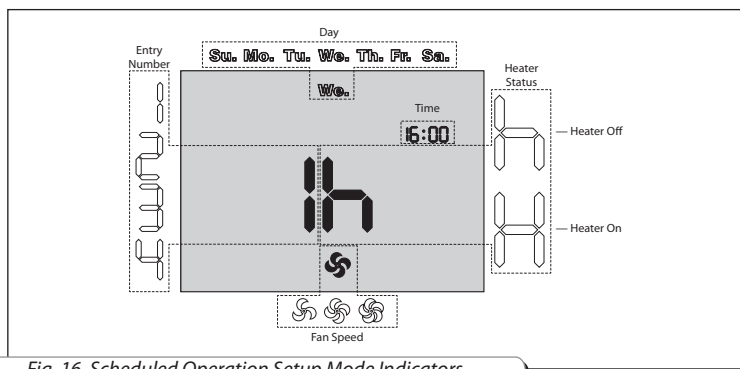

Fig. 16. Scheduled Operation Setup Mode Indicators

- To select the scheduled operation setup mode parameters hold the **M** button and use the **▲** and **▼** buttons to make the selection as necessary.
  - Press the **▲** and **▼** buttons to set the parameter values.
- Scheduled Operation Setup Mode Parameters (Fig. 16):
- Entry Number — there are four entries for each day.
  - Day — day setting.
  - Heater Status — heater setting for the current entry. **H** - Heater On, **h** - Heater Off.
  - Fan Speed — fan speed setting for the current entry.
  - Time — time setting for the current entry.
- To copy the entries to the following day press and hold the **M** button, then press **↻**. Please note that copying entries from Sunday onto Monday is not possible.
  - To exit the scheduled operation setup mode press the **⏻** button on the wall-mounted control panel or the **⏻** button on the remote control.

A sample scheduling sequence is given in Table 3. By default the scheduled operation mode is set up for cooling. To set up the unit for heating operation change the heater settings — set **H**.

Table 3. Sample programming sequence

Day	Entry Number											
	1			2			3			4		
	Start Time	Mode	Heater Status	Start Time	Mode	Heater Status	Start Time	Mode	Heater Status	Start Time	Mode	Heater Status
Mo.	07:00	2 speed	Off	08:00	1 speed	Off	17:00	2 speed	Off	22:00	1 speed	Off
Tu.	07:00	2 speed	Off	08:00	1 speed	Off	17:00	2 speed	Off	22:00	1 speed	Off
We.	07:00	2 speed	Off	08:00	1 speed	Off	17:00	2 speed	Off	22:00	1 speed	Off
Th.	07:00	2 speed	Off	08:00	1 speed	Off	17:00	2 speed	Off	22:00	1 speed	Off
Fr.	07:00	2 speed	Off	08:00	1 speed	Off	17:00	2 speed	Off	22:00	1 speed	Off
Sa.	10:00	2 speed	Off	12:00	2 speed	Off	17:00	2 speed	Off	23:00	1 speed	Off
Su.	10:00	2 speed	Off	12:00	2 speed	Off	17:00	2 speed	Off	23:00	1 speed	Off



### 9. Alarms.

In case of an emergency the unit switches off while the alarms are displayed on the wall-mounted panel screen (Fig. 17). The list of possible alarms is given in Table. 4.

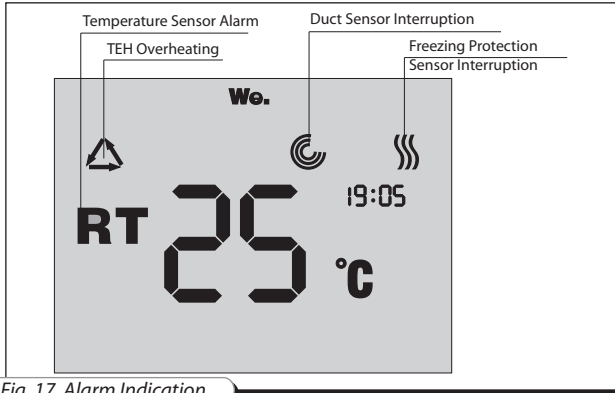

Fig. 17. Alarm Indication

Table 4. Unit-Specific Alarms

ALARM	INDICATION	ELIMINATION METHOD
TEH Overheating		TEH Overheating. Contact the maintenance service.
Temperature Sensor Alarm	<b>RT</b>	Short-circuiting of one or two temperature sensors. Contact the maintenance service
Duct Sensor Interruption	<b>RT</b>	Contact the maintenance service to restore the duct sensor.
Freezing Protection Sensor Interruption	<b>RT</b>	Contact the maintenance service to restore the freezing protection sensor.



## TECHNICAL MAINTENANCE

The unit requires maintenance works 3-4 times per year. Maintenance includes regular cleaning and the following operations:

### **1. Filter maintenance (3-4 timed per year).**

Dirty filters increase air resistance in the system and reduce supply air volume. Clean the filters as required but at least once in 3-4 months. Use a vacuum-cleaner to remove the contamination or use a new filter. Contact your seller for new filters.

Filter removal procedure (Fig. 18):

1. Pull the latch plates.
2. Turn the latch plates by 90°.
3. Open the unit access door.
4. Replace the extract and supply filter.

### **2. Heat exchanger inspection (once per year).**

Some dust can get accumulated on the heat exchanger block even in case of regular maintenance of the filters. To maintain the high heat exchange efficiency, regular cleaning is required. To clean the heat exchanger pull it out of the unit and flush it with warm soap or mild detergent water solution. Re-install the dry heat exchanger to the unit.

### **3. Fan inspection (once per year).**

Even in case of regular filter maintenance, some dust and grease can get accumulated inside the fans and reduce the unit performance and supply air flow.

Clean the fans with a soft brush or cloth. No water and abrasive detergent, sharp objects or solvents are allowed for cleaning to prevent the impeller damage.

### **4. Condensate drainage (once per year).**

The drain pipes may get clogged with extracted particles. Pour some water inside the drain pan and check the pipe for clogging. Clean the U-trap and drain pipe if required.

### **5. Supply air flow control (twice per year).**

Leaves and other pollutions can clog the supply air grille and reduce the unit performance and supply air volume. Check the supply grille twice per year and clean it as required.

### **6. Ductworks inspection (once in 5 years).**

Even regular technical maintenance of the unit may not completely prevent dirt accumulation in the air ducts, which impairs the unit performance. The air duct maintenance mens their regular cleaning or replacement.

### **7. Control Unit Maintenance (as required).**

**The control unit must be serviced by an expert qualified for unassisted operations with electrical installations up to 1000 V and made familiar with the present operation manual. Disconnect the unit from the power mains prior to the control unit maintenance.**

Control unit maintenance sequence(Fig. 18):

1. Pull the latch plates.
2. Turn the latch plates by 90°.
3. Open the unit access door and release the stoppers by removing two M4 screws. Then take off it from the door profile.
4. Remove the filters from the unit.
5. Remove the heat exchanger by pulling its band.
6. Remove the screws and take off the protecting cover.
7. Remove the fastening screws of the swivel control unit securing the swivel control unit panel. Remove the control unit lid for accessing the control unit.

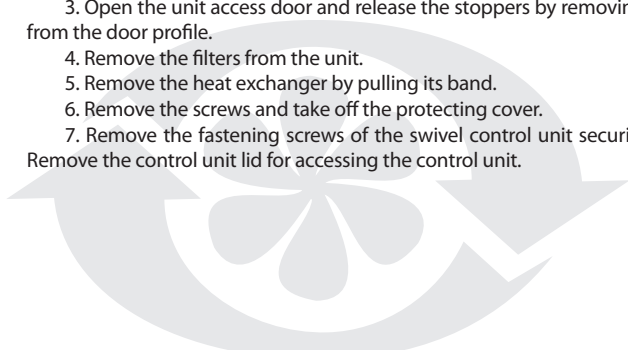

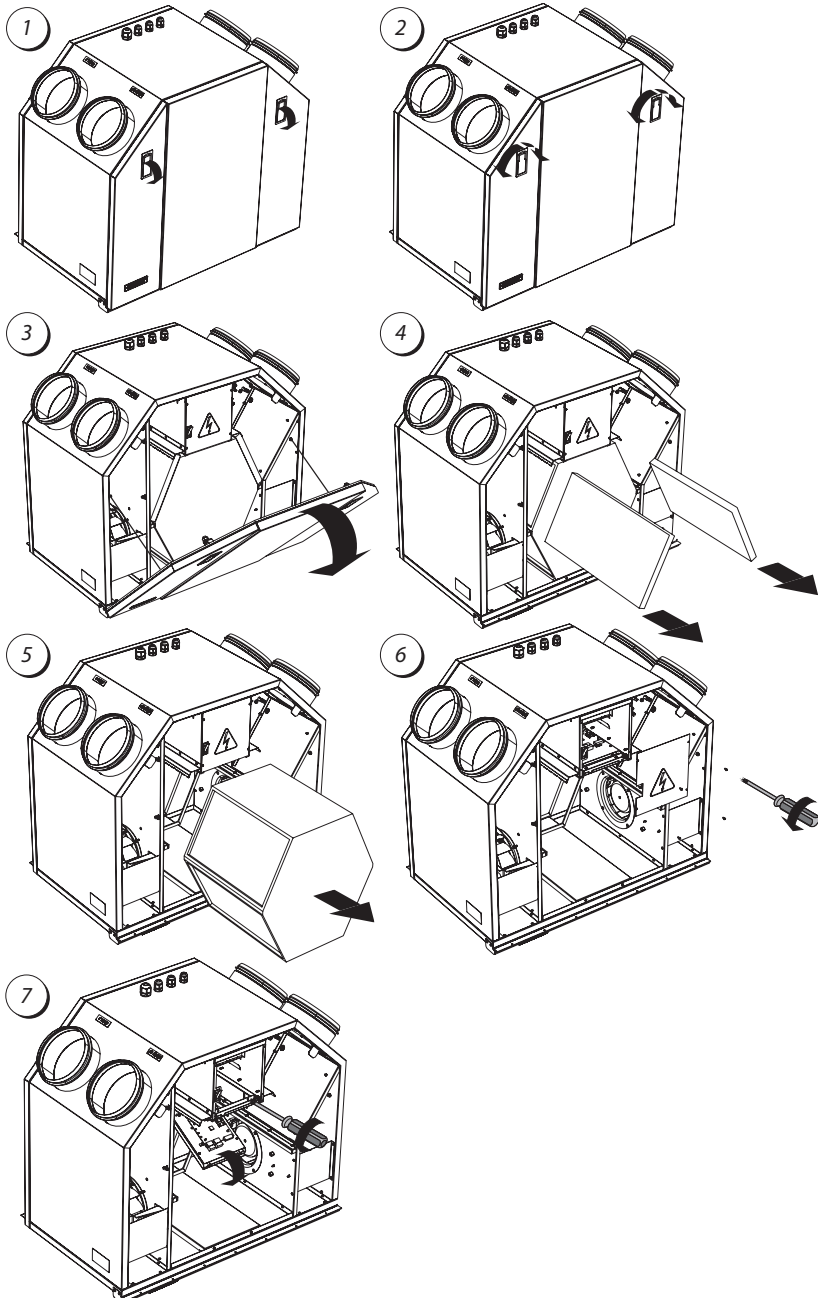

Fig. 18. Control unit maintenance

**FAULT HANDLING**
**Troubleshooting and fault handling**

Trouble	Possible Reasons	Fault handling
Fan (Fans) will not start	The unit is not connected to the power mains.	Make sure that the unit is properly connected to the power mains and troubleshoot a connection error, if required.
Supply air too cold	Clogged extract filter.	Clean or replace the extract filter.
	Ice buildup in the heat exchanger.	Check for ice in the heat exchanger. If there is ice in the heat exchanger, let it melt before switching the unit back on.
Low air flow	Filter, fan or heat exchanger clogging.	Clean or replace the filters; Clean the fans and the heat exchanger.
	Air handling system clogged or damaged.	Check for unobstructed diffuser opening, check the exhaust hood and the supply duct grille and clean them, if necessary; Make sure that the air ducts are clean and undamaged.
Noise and vibration	Fan impellers are clogged.	Clean the fan impellers.
	Fan fastening bolts are loose.	Make sure the fastening screws are tight.
Water leakage	The drain line is clogged, damaged or improperly arranged.	Clean the drain line, if necessary. Check the drain line slant, inspect the U-trap and make sure the drain line is equipped with frost protection.



### STORAGE AND TRANSPORTATION RULES

Store the unit in the manufacturer's original packing box in a closed ventilated premise with temperature range from +10°C to +40°C and relative humidity less than 80% (at +20°C).

Vapours or particles which can cause corrosion or damage the insulation or connection tightness are not allowed in the storage environment.

Use hoist machinery for handling and transportation to prevent possible mechanical damages of the unit. Fulfill the requirements for transportation of the specified cargo type during cargo-handling operations.

Use any vehicle types for the unit transportation provided that it is protected against mechanical or weather damage.

Avoid any mechanical shocks and strokes during handling operations.

### MANUFACTURER'S WARRANTY

Manufacturer hereby guarantees normal performance of the unit during two years from the date of retail sale provided compliance with transport, storage, mounting and operation regulations.

In case of no confirmation of the sales date the warranty period is calculated from the manufacturing date. In case of failures in the unit operation during the warranty period the manufacturer will accept reclamations and complaints from the owner of the device only after receiving technically sound act with detailed description of the failure.

Unit damage as a result of unauthorized tampering with the circuit diagram is not a warranty case.

For warranty and post-warranty services contact your seller or the product manufacturer. In case of warranty reclamation, submit the present user's manual with a stamp of the trade company, filled connection certificate and the warranty card. Both warranty and post-warranty services for the unit are provided at the manufacturing facility.



**RECLAMATIONS AND CLAIMS FOR REPLACEMENT SHALL NOT BE ACCEPTED WITHOUT A COMPLETED CONNECTING CERTIFICATE.**



**THE MANUFACTURER IS NOT RESPONSIBLE FOR ANY MECHANICAL OR PHYSICAL DAMAGES RESULTING FROM THE MANUAL REQUIREMENTS VIOLENCE, THE UNIT MISUSE OR GROSS MECHANICAL EFFECT.**

**FULFIL THE REQUIREMENTS SET IN THE USER'S MANUAL TO ENSURE PROPER FUNCTIONING OF THE UNIT AND LONG SERVICE LIFE.**



### ACCEPTANCE CERTIFICATE

**The air handling unit with heat recovery VUT 350 (E)U EC has been duly certified as serviceable.**

We hereby declare that the product complies with the essential protection requirements of Electromagnetic Council Directive 2004/108/EC, 89/336/EEC and Low Voltage Directive 2006/95/EC, 73/23/EEC and CE-marking Directive 93/68/EEC on the approximation of the laws of the Member States relating to electromagnetic compatibility.

This certificate is issued following test carried out on samples of the product referred to above.

Stamp of the acceptance inspector \_\_\_\_\_

Date of production \_\_\_\_\_

**Sold by**

Name of the trade company, stamp of the shop \_\_\_\_\_

\_\_\_\_\_

Date of sale \_\_\_\_\_

### CONNECTION CERTIFICATE

The air handling unit with heat recovery VUT 350 (E)U EC is connected to power mains pursuant to the requirements stated in this user's operation manual by the electrician:

Company name \_\_\_\_\_

Electrician's name \_\_\_\_\_

Date \_\_\_\_\_ Signature \_\_\_\_\_

\_\_\_\_\_

### WARRANTY CARD

\_\_\_\_\_

\_\_\_\_\_

\_\_\_\_\_

\_\_\_\_\_

\_\_\_\_\_

\_\_\_\_\_

\_\_\_\_\_





