



SINGLE-ROOM VENTILATION

for schools and public spaces



CONTENTS

Introduction	page 4
Design guidelines	page 6
DVUT HB EC, DVUE HB EC – floor-mounted ventilation units	page 8
DVUT PB EC – ventilation units for suspended mounting	page 16

PROBLEM N°1: POOR AIR QUALITY

Inadequate ventilation of classrooms, offices and conference halls leads to poor air quality – specifically: elevated humidity and CO₂ levels and reduced oxygen content. These effects can cause eye dryness and irritation, poor concentration and fatigue.

It has been scientifically proven that poor air quality reduces work capacity of adults by 5-10 %. Poor air quality can have even more pronounced effect on children and have adverse effects on concentration and potential academic achievement.

The normal practice of classroom ventilation by opening windows only provides a short-term solution for the problem of poor air quality and it is at the cost of the warm air that is lost in the process. As a result, the CO₂ concentration in spaces that are intermittently ventilated by airing exceeds acceptable levels by several times.

Unlike this conventional approach, single-room ventilation ensures consistently high air quality in classrooms whilst maintaining the air temperature.

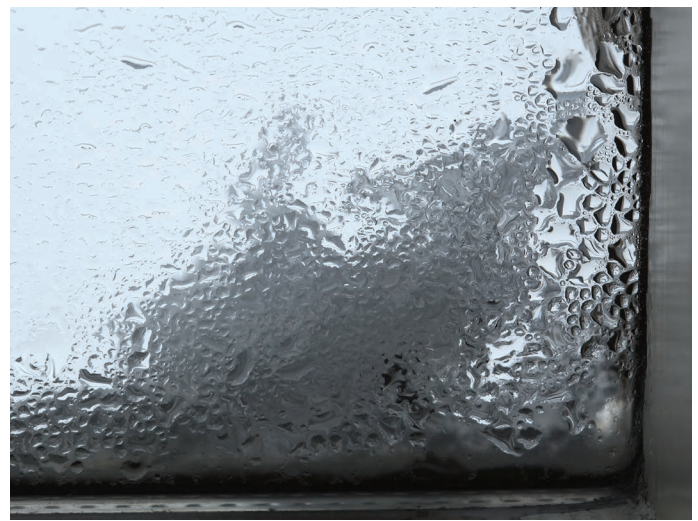

PROBLEM N°2: HEAT LOSSES

Most retrofit projects of schools and community buildings are focused towards the reduction of heat and energy costs. Fitting modern windows and doors is an essential part of the process as well as removing any airbricks and trickle vents in order to try and create an airtight living environment and prevent any heat losses through gaps. This newly created, airtight environment, however, can create new issues with regards to air quality and the reduction of CO₂ and VOCs which would normally be removed passively by the property's air permeability. Air tight spaces can be ventilated very efficiently and effectively using mechanical ventilation with heat recovery.

PROBLEM N°3: LACK OF SPACE FOR VENTILATION FACILITIES IN RETROFITTING PROJECTS

Retrofitting existing structures presents a host of engineering challenges which often require creative solutions. Ensuring efficient ventilation in such projects is no exception. Some buildings completely lack free space for air ducts and ventilation equipment. In such cases central ventilation systems are not a realistic option.

However, such engineering challenges can be met by fitting the treated spaces with single-room ventilation systems which do not require dedicated air ducts.

High levels of humidity promote mould and germs which may trigger asthma and other allergies. Proper ventilation is essential in order to eliminate this problem. Chemical compounds known as VOCs (volatile organic compounds) released by furniture, paint, carpets, cleaning products and a variety of other household items all contribute to indoor air pollution. Carbon dioxide is a natural component of the Earth's atmosphere with outdoor air concentration ranging from 350 ppm in the country to 500 ppm in the city.

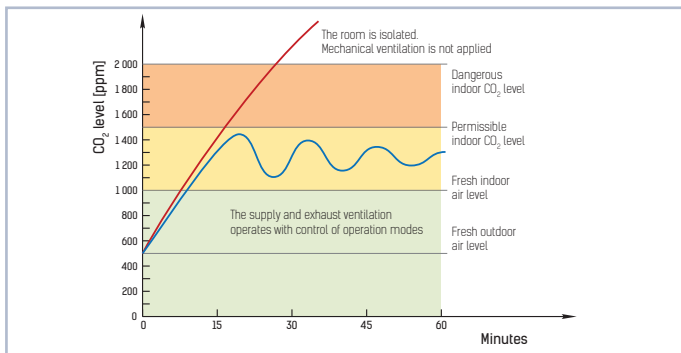

ADVANTAGES OF SINGLE-ROOM VENTILATION SYSTEMS

- Unit air flow and type are selected based on the individual requirements of each particular space.
- Each space is ventilated on demand.
- The speed of DVUT units is set automatically.
- Single-room ventilation systems are much easier to design due to the absence of air ducts.
- Fresh air is supplied through a short wall duct. No energy is wasted pushing air through long air ducts.
- Single-room ventilation improves fire safety due to the absence of air ducts between individual spaces.

DISADVANTAGES OF CENTRAL VENTILATION SYSTEMS

- Central ventilation units can be large and require a dedicated space for installation.
- As a retrofit solution there can be some difficulties with installing ducting between floors or through existing ceiling voids

Central ventilation system example

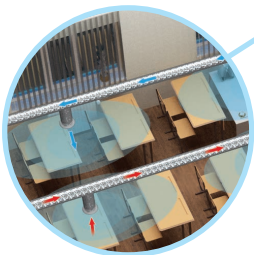
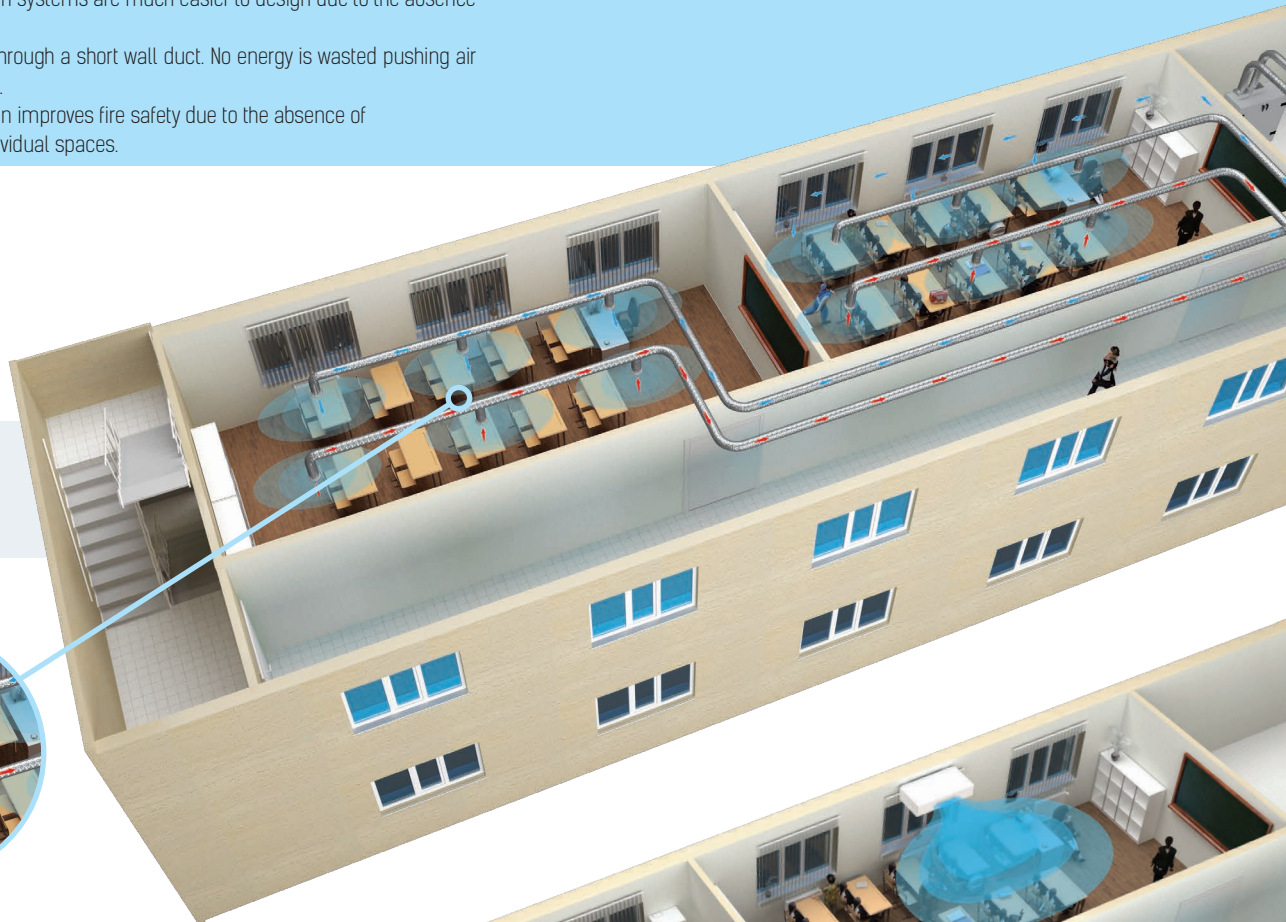

Hyperventilation in the empty room

Single-room ventilation system example



DESIGN GUIDELINES

DIN EN 15251 standard specifies indoor environmental input parameters for design and assessment of energy performance of buildings addressing indoor air quality, thermal environment, lighting and acoustics.

Category	Description
1	High standard. Recommended for rooms used by sensitive occupants with special needs (e.g. people with disabilities or patients undergoing medical treatment, infants, elderly people etc.).
2	Normal standard. Recommended for newly erected and renovated buildings.
3	Targeted/moderate standard. Can be applied to existing buildings.
4	Parameters beyond the above categories. This category can only be applied during a limited period.

The following table contains recommended ventilation system air flow per person as per DIN EN 13779. The aforementioned airflow is given in consideration of the contaminants released by furniture and construction materials.

Category	Measurement unit		Outdoor airflow							
			Non-smoking space				Smoking space			
			Range		Standard value		Range		Standard value	
1	l/s	m ³ /h	> 15	> 54	20	72	> 30	> 108	40	144
2	l/s	m ³ /h	10–15	36–54	12,5	45	20–30	72–108	25	90
3	l/s	m ³ /h	6–10	21,6–36	8	28,8	12–30	43,2–108	16	57,6
4	l/s	m ³ /h	< 6	< 21,6	5	18	< 12	< 43,2	10	36

The minimum ventilation air flow per pupil based on maximum allowable concentration of CO₂ is as follows.

Age group norm			
Approximate age	Reference value 1200 ppm	Reference value 1000 ppm	Target audience
0–6	19 m ³ /h	25 m ³ /h	Kindergarten
6–10	19 m ³ /h	25 m ³ /h	Primary school
10–14	23 m ³ /h	30 m ³ /h	Secondary school
14–19	24 m ³ /h	33 m ³ /h	Vocational school
Over 19	25 m ³ /h	34 m ³ /h	University
Teacher	28 m ³ /h	37 m ³ /h	

Noise level requirements as per DIN EN 15251 and DIN EN 13779:

Building/room type	Sound pressure recommended range, dBA
Open-space office	35–40
Conference hall	30–40
Classroom, kindergarten	35–45
Cafeterias/restaurants	35–50
Retail store	35–50

CALCULATION EXAMPLE

Let us calculate a classroom ventilation system. The classroom is to accommodate 20 children aged 10-14 and one adult teacher. The CO₂ concentration must be maintained at 1000 ppm.



Required fresh airflow rate: **637 m³/h**





DVUT HB EC, DVUE HB EC

Floor-mounted single-room air handling units in a heat- and sound-insulated casing



Air flow:
up to 1240 m³/h



Heat recovery efficiency:
up to 96 %

DESCRIPTION

The **DVUT HB EC** and **DVUE HB EC** air handling units are intended for single-room ventilation of schools, offices and other public and commercial spaces.

These air handling units do not require a duct system and provide a simple yet efficient ventilation solution for newly built and renovated spaces.

FEATURES

- Efficient supply and exhaust ventilation of individual spaces.
- Modification with an electric preheater or reheater available.
- Modification with an enthalpy membrane heat exchanger available.
- Low-energy EC fans.
- Low noise operation (25-35 dBA).
- Simple installation.
- Contemporary design.

OPERATING PRINCIPLE

Warm, stale indoor air passes through the filter and the heat exchanger and is then extracted outdoors through the wall duct by the centrifugal extract fan. Cold outdoor air passes through the filters and the heat exchanger and then is supplied by means of the centrifugal supply fan.

The heat of extracted air is transferred to supply air by means of the heat exchanger, providing comfortable fresh air temperature and reducing costs for its heating.



DESIGNATION KEY

Unit series	Rated air flow [m ³ /h]	Installation	Bypass	Electric heaters	Drain pump	Motor type	Control
DVUT – unit with plastic heat exchanger	300; 500; 1200	H – floor-mounted with horizontal spigots	B – bypass damper	– – no heater E – electric preheater E2 – electric preheater and reheater	– – without drain pump DN – in-built drain pump	EC – synchronous motor with electronic control	A14 A21

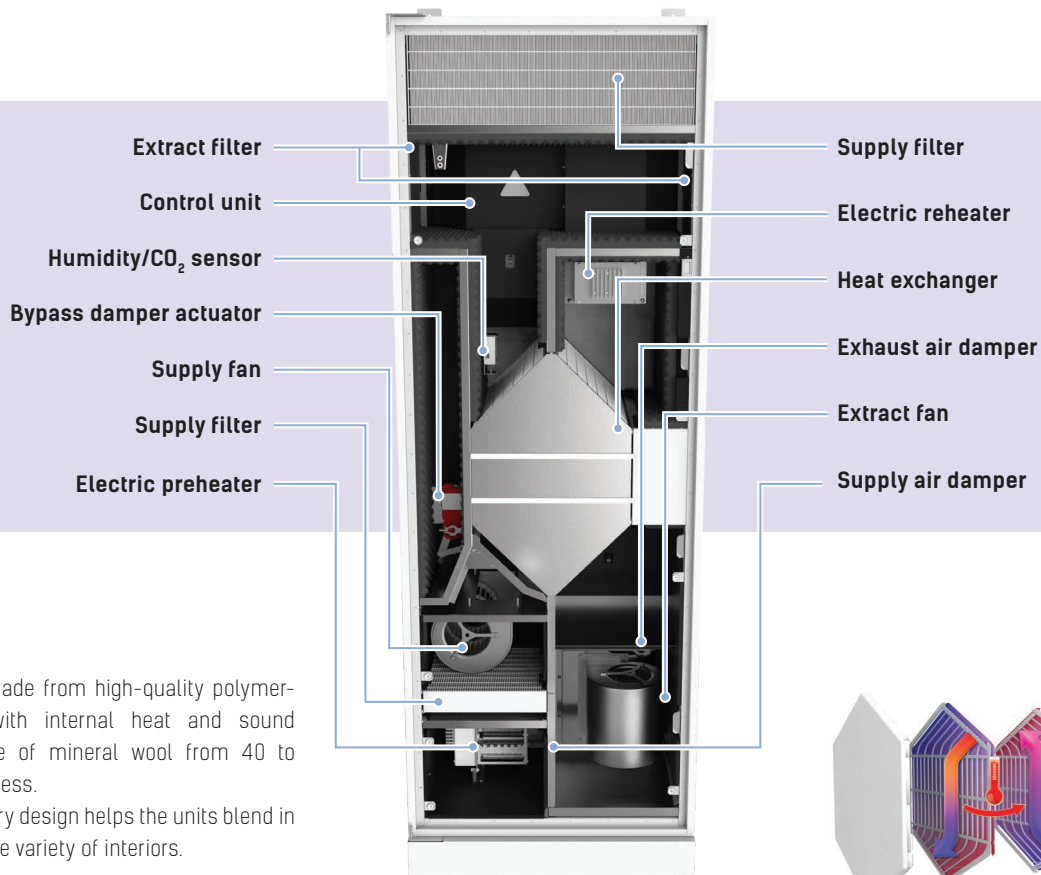

DVUT HBE EC, DVUE HBE EC

CASING

The casing is made from high-quality polymer-coated steel with internal heat and sound insulation made of mineral wool from 40 to 80 mm in thickness. The contemporary design helps the units blend in nicely with a wide variety of interiors.

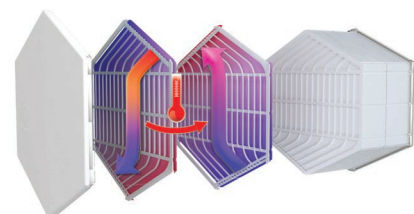

AIR DAMPERS

Supply and exhaust dampers are closed automatically while the unit is off to prevent drafts.

PREHEATING

The DVUT HBE EC and DVUT HBE2 EC units are equipped with an electric preheater to prevent heat exchanger freezing.

The DVUE units are equipped with a counter-flow enthalpy heat exchanger. In the cold season the extract air heat and moisture are transferred to the supply air stream through the enthalpy membrane. Heat recovery minimises heat losses from ventilation.

AIR FILTRATION

Filtering class depends on standard sizes and is specified in the table with characteristics. Filtering class depends on standard sizes and is specified in the table with characteristics.

REHEATING

The DVUT HBE2 EC units are equipped with electric reheaters to raise the supply air temperature.

In the warm season the outdoor air heat and moisture are transferred to the extract air stream through the enthalpy membrane. This enables considerable reduction of the supply air temperature and humidity, which reduces the air conditioning load.

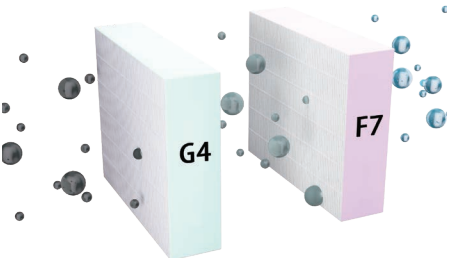

BYPASS

The units are equipped with a bypass for summer ventilation.

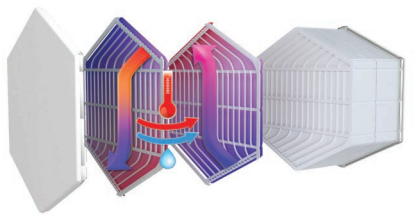

FANS

The units feature high-performance, electronically commutated (EC), external rotor motors with forward curved blades. These state-of-the-art units offer excellent energy efficiency. In addition to that, EC motors combine high performance and optimum control over the entire speed range. EC motors have an excellent power efficiency (up to 90 %).

HEAT EXCHANGER

The DVUT units feature a counter-flow heat exchanger made of polystyrene. The heat of the extract air is transferred to the supply air via the heat exchanger which greatly helps reduce ventilation heat losses. This can lead to formation of condensate that is collected in a special drain pan and discharged into the sewage system.

In the warm season the outdoor air heat is transferred to extract air. This enables considerable reduction of the supply air temperature which reduces the air conditioning load.

UNIT CONTROL AND OPERATION

• Freeze protection

There are two methods of protecting the heat exchanger against freezing in cold conditions.

In units without an electric preheater the supply fan is shut down automatically, using the feedback from the extract air temperature sensor, to let the warm extract air thaw the heat exchanger. The supply fan then re-activates and the unit reverts to normal operation.

In units with an electric preheater the supply air is warmed up before entering the heat exchanger which prevents freezing. This method ensures a continuous balanced air exchange.

• Control

The units **DVUT/DVUE HB EC A21** are equipped with an in-built control system. An A21 controller allows integrating the unit into the **Smart Home system** or **BMS (Building Management Systems)**. Remote control panel is not included in the delivery set and is available as specially ordered accessory. The unit is controlled via Wi-Fi by means of the VENTS AHU mobile application that must be downloaded.



Google play

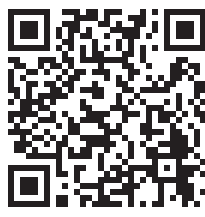

Download on the App Store



The units **DVUT/DVUE HB EC A14** are equipped with an in-built control system and a wall-mounted sensor control panel A14 with a LED indication.

Function	A21	A14
Wired remote control panel	Option (A22) 	A14 
Wired remote LCD control panel	Option (A25) 	-
Wireless remote control panel	Option (A22 Wi-Fi) 	-
BMS	RS-485 Wi-Fi Ethernet MODBUS (RTU, TCP)	-
Vents Cloud Server	+	-
Control by a mobile application via Wi-Fi	+	-
Freeze protection	+	+
Bypass control	Auto + manual	Manual
Weekly schedule operation	+	-
Filter maintenance warning	According to filter timer	According to filter timer
	According to pressure switch of filter clogging	
Alarm indication	+	+
Speed selection	+	+
Timer	+	-
RH% sensor	Option	Option
CO ₂ sensor	Option	Option
VOC sensor	Option	Option
PM2.5 sensor	Option	Option
Boost mode	+	-
Fireplace mode	+	-
Preheating	Option	-
Reheating	Option	-
Cooler connection	Option	-
Fire alarm sensor connection	Option	Option
Supply air temperature control	+	-

TECHNICAL SPECIFICATIONS

Model	DVUT 300 HB EC	DVUT 300 HBE EC	DVUT 300 HBE2 EC	DVUE 300 HB EC	DVUE 300 HBE EC	DVUE 300 HBE2 EC	DVUT 500 HB EC	DVUT 500 HBE EC	DVUT 500 HBE2 EC	DVUT 1200 HB EC	DVUT 1200 HBE EC	DVUT 1200 HBE2 EC
Supply voltage [V]/50 (60) Hz	1~230											
Maximum power consumption without an electric heater [W]	125						230			350		
Preheater power [W]	-	1400		-	1400		-	1400		-	6300	
Reheater power [W]	-	-	1400	-	-	1400	-	-	2800	-	-	6300
Maximum unit current without an electric heater [A]	0,9						1,7			1,6		
Maximum unit current with an electric heater [A]	0,9	7	13,1	0,9	7	13,1	1,7	7,8	20	1,6	9,6	18,7
Maximum air flow [m³/h]	320						580			1240		
RPM [min ⁻¹]	2150						1280			3630		
Sound pressure level at 1 m [dBA]	31						35			34		
Sound pressure level at 3 m [dBA]	21						25			24		
Transported air temperature [°C]	-25...+40											
Casing material	polymer coated steel											
Insulation	40 mm mineral wool											
Filter	extract	G4x2									G4	
	supply	G4, F8 (Option: F8 + Carbon; H11)									G4 + (Option: F7)	
Connected air duct diameter [mm]	Ø 200						Ø 250			Ø 400		
Weight [kg]	138	139	140	136	137	138	191	193	194	394	398	402
Heat exchange efficiency [%]	78-92			73-89			75-94			84-96		
Heat exchanger type	counter-flow											
Heat exchanger material	polystyrene			enthalpy			polystyrene			polystyrene		
SEC class	A									A+		

DVUT HB EC, DVUE HB EC

OVERALL DIMENSIONS, MM

Model	W	W1	W2	L	L1	H	H1	H2	D
DVUT 300 HB EC	620	230	195	470	520	1770	1476	294	200
DVUT 500 HB EC	750	290	230	535	585	2170	1883	337	250

OVERALL DIMENSIONS, MM

Model	H	H1	D	H3	H4	H5	L	L1	L2	L3
DVUT 1200 HB EC	2106	2000	397	545	1110	70	1900	1951	265	535

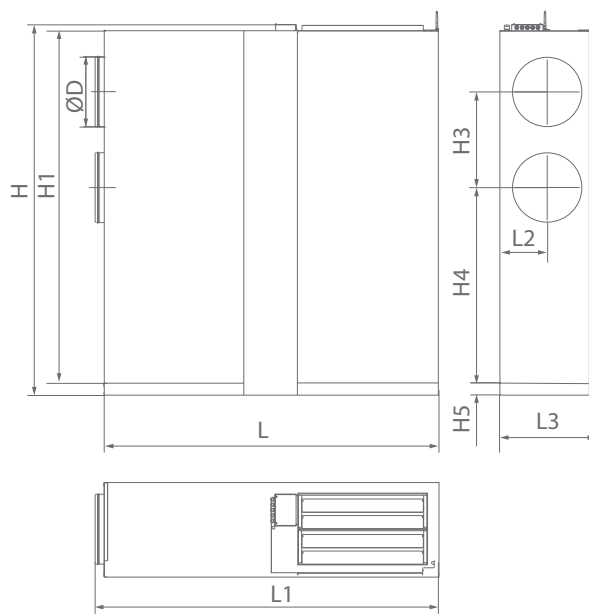
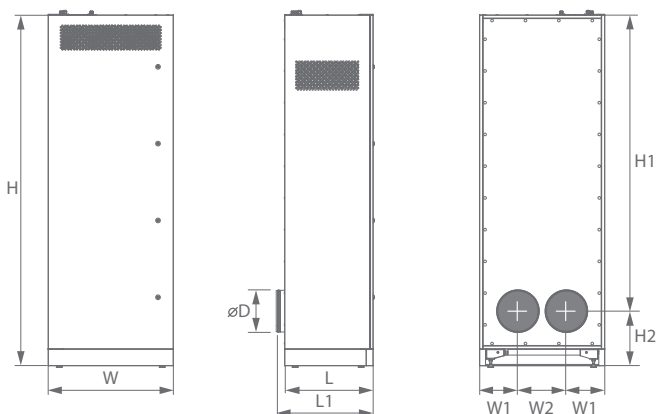

DVUT 300 HB/HBE/HBE2 EC

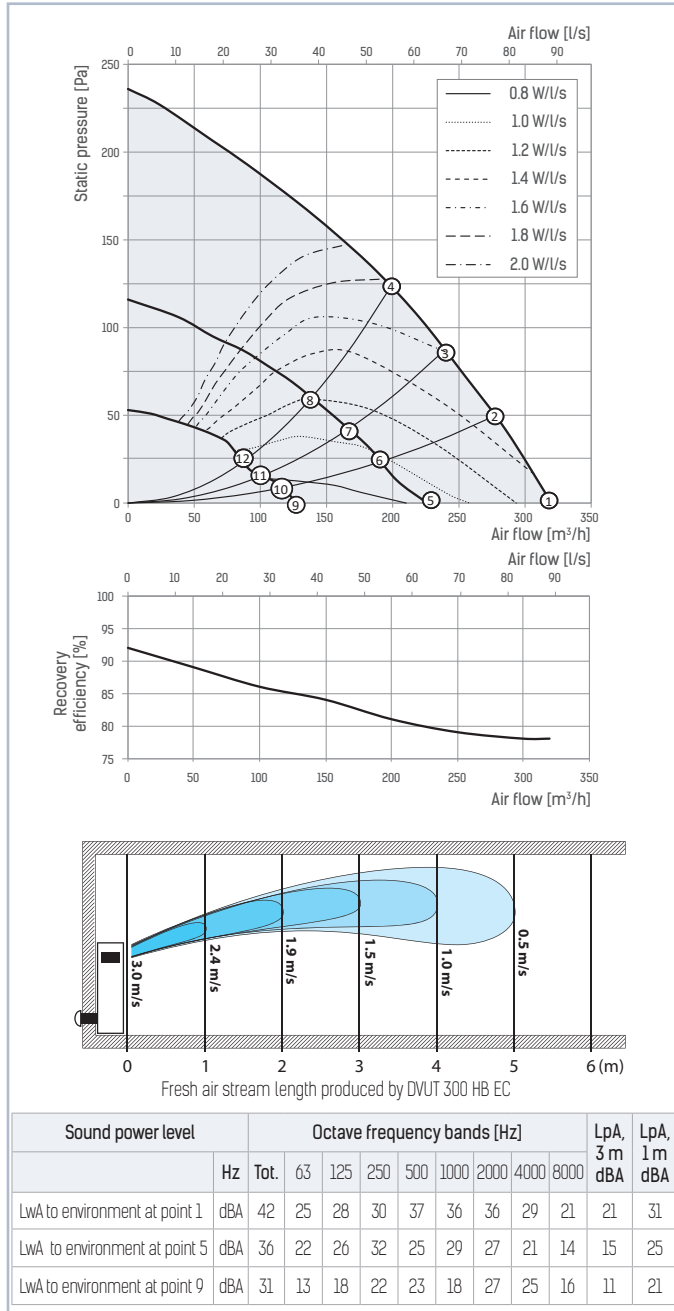

DVUT 500 HB/HBE/HBE2 EC

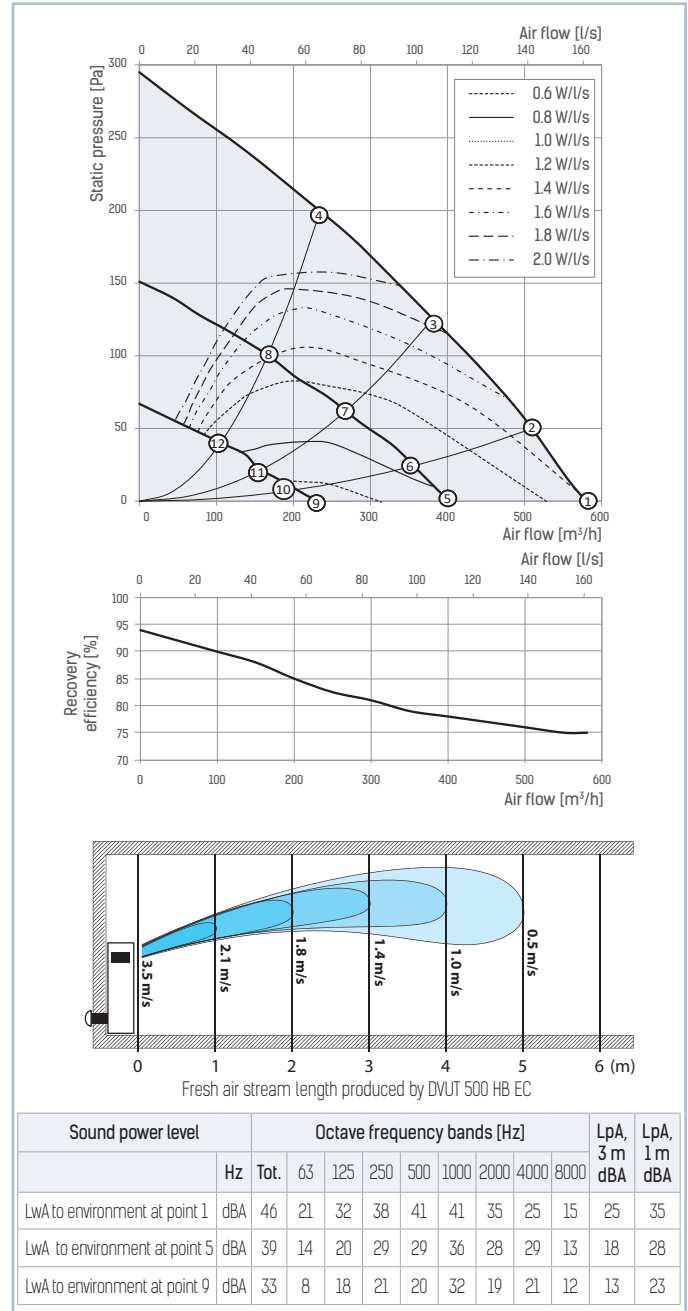

Point	Power [W]			Sound pressure level at 3 m (1m) [dBA]		
	DVUT/DVUE 300 HB EC DVUT/DVUE 300 HBE EC DVUT/DVUE 300 HBE2 EC	DVUT 500 HB EC DVUT 500 HBE EC DVUT 500 HBE2 EC	DVUT 1200 HB EC DVUT 1200 HBE EC DVUT 1200 HBE2 EC	DVUT/DVUE 300 HB EC DVUT/DVUE 300 HBE EC DVUT/DVUE 300 HBE2 EC	DVUT 500 HB EC DVUT 500 HBE EC DVUT 500 HBE2 EC	DVUT 1200 HB EC DVUT 1200 HBE EC DVUT 1200 HBE2 EC
1	125	230	350	21(31)	25(35)	24(34)
2	113	215	356	20(30)	25(35)	24(34)
3	108	170	358	20(30)	24(34)	23(33)
4	100	168	356	19(29)	24(34)	23(33)
5	55	98	127	15(25)	18(28)	15(25)
6	52	92	129	15(25)	18(28)	15(25)
7	50	85	129	15(25)	18(28)	14(24)
8	45	75	129	14(24)	17(28)	14(24)
9	24	33	50	11(21)	13(23)	11(21)
10	23	31	50	11(21)	13(23)	11(21)
11	23	30	50	11(21)	12(22)	11(21)
12	23	29	48	10(20)	12(22)	10(20)

DVUT 1200 HB/HBE/HBE2 EC

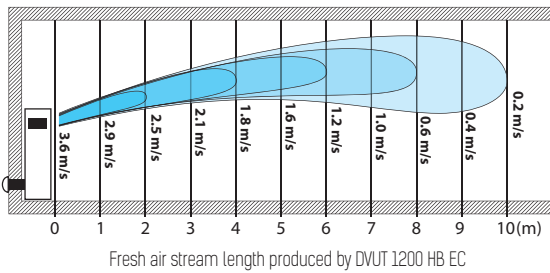
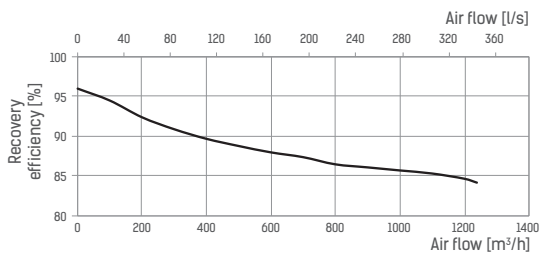
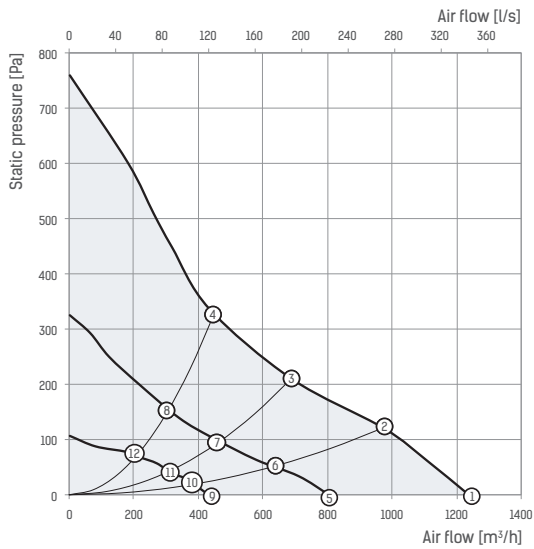

Fresh air stream length produced by DVUT 1200 HB EC

Sound power level	Octave frequency bands [Hz]									LpA, 3 m dBA	LpA, 1 m dBA	
	Hz	Tot.	63	125	250	500	1000	2000	4000			8000
LwA to environment at point 1	dBA	44	31	35	40	37	36	36	28	17	24	34
LwA to environment at point 5	dBA	38	27	31	33	29	30	27	22	13	17	27
LwA to environment at point 9	dBA	32	21	27	21	25	17	19	24	16	11	21

ACCESSORIES

Name	Image	DVUT 300 HB EC A14	DVUT 300 HB EC A21	DVUT 500 HB EC A14	DVUT 500 HB EC A21	DVUT 1200 HB EC A21	
Outer ventilation hood made of white coated stainless steel		NB DVUT 300 HB white		NB DVUT 500 HB white		NB DVUT 1200 HB white	
Outer ventilation hood made of brushed stainless steel		NB DVUT 300 HB chrome		NB DVUT 500 HB chrome		NB DVUT 1200 HB chrome	
Outer ventilation grille made of aluminium		MVMA 200 bVn Al		MVMA 250 bVn Al		MVMA 400 bVn Al	
G4 panel filter		SF 308x238x22 G4 PPI		SF 450x257x27 G4 PPI		SF 450x395x48 G4 PET	
G4 panel filter		SF 265x213x48 G4		SF 318x290x22 G4		SF 540x450x48 G4	
F7 panel filter		-		-		SF 540x450x48 F7	
F8 panel filter		SF 384x273x60 F8		SF 318x290x60 F8		-	
F8 panel carbon filter		SF 533x135x48 F8 C		SF 666x196x48 F8 C		-	
HEPA panel filter		SF 533x135x60 H11		SF 666x196x60 H11		-	
VOC sensor (0-10 V)		-	DPWQ30600	-	DPWQ30600	DPWQ30600	
CO ₂ sensor (0-10 V)		-	DPWQ40200	-	DPWQ40200	DPWQ40200	
Humidity sensor (0-10 V)		-	DPWC11200	-	DPWC11200	DPWC11200	
Humidity sensor (NO)						HR-S	
Humidity sensor						HV2	
Hydraulic U-trap						SG-32	
Drain pump						DN-2	

DVUT PB EC

Suspension-mounted single-room air handling units in a heat- and sound-insulated casing.



Air flow:
up to 1000 m³/h



Heat recovery efficiency:
up to 94 %.

DESCRIPTION

The DVUT PB EC air handling units are intended for single-room ventilation of schools, offices and other public and commercial spaces.

The air handling units do not require a duct system and provide a simple yet efficient ventilation solution for newly built and renovated spaces.

FEATURES

- Efficient supply and exhaust ventilation of individual spaces.
- Modification with an electric preheater or reheater available.
- Low-energy EC motors.
- Very quiet operation (25-35 dBA).
- Supply and extract air purification by means of in-built filters.
- Simple installation.
- Contemporary design.

OPERATING PRINCIPLE

Warm, stale air passes through the filter and the heat exchanger and is then extracted outdoors through the wall duct by the centrifugal extract fan. Cold outdoor air passes through the filters and the heat exchanger and is then supplied by means of the centrifugal supply fan. This air is warmed up in the heat exchanger, providing fresh air supply into a premise and maintaining comfortable temperature.

CASING

The casing is made from high-quality polymer-coated steel with internal heat and sound insulation made of mineral wool 30 mm in thickness. The contemporary design helps the units blend in nicely with a wide variety of interiors.

AIR DAMPERS

Supply and exhaust dampers are closed automatically while the unit is off to prevent drafts.



DESIGNATION KEY

Unit series	Rated air flow [m ³ /h]	Installation	Bypass	Electric heaters	Drain pump	Motor type	Control
DVUT – unit with plastic heat exchanger	300 500 1000	P – suspended with horizontal spigots P1 – suspended with vertical spigots	B – bypass damper	– – no heater E – electric preheater E2 – electric preheater and reheater	– – without drain pump DN – in-built drain pump	EC – synchronous motor with electronic control	A21

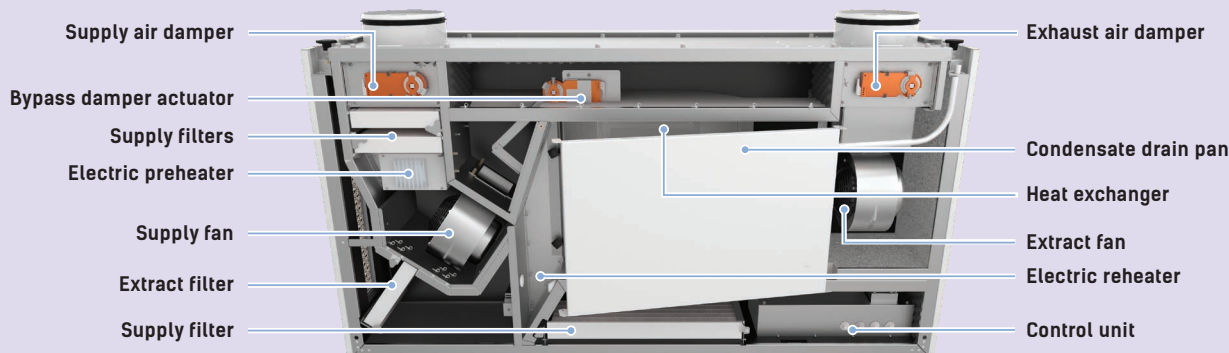

AIR FILTRATION

Supply and extract air is purified by means of panel filters. The filtering class depends on standard sizes.

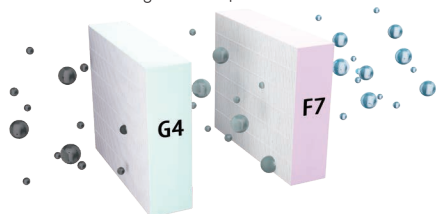

FANS

The units feature high-performance, electronically commutated (EC) external rotor motors with forward curved blades. These state-of-the-art units offer excellent energy efficiency. In addition to that, EC motors combine high performance and optimum control over the entire speed range. EC motors have an excellent power efficiency (up to 90 %).

HEAT EXCHANGER

The DVUT unit features a counter-flow heat exchanger made of polystyrene. In the cold season the heat from the extract air is transferred to the supply air via the heat exchanger which greatly helps reduce ventilation heat losses. This can lead to formation of condensate that is collected in a special drain pan and discharged into the sewage system. In the warm season the outdoor air heat is transferred to extract air. This enables considerable reduction of the supply air temperature which reduces the air conditioning load.

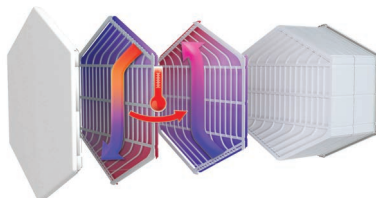

Control

The units **DVUT PB EC A21** are equipped with an in-built control system. An A21 controller allows integrating the unit into the **Smart Home system** or **BMS (Building Management Systems)**. Remote control panel is not included in the delivery set and is available as specially ordered accessory. The unit is controlled via Wi-Fi by means of the VENTS AHU mobile application that must be downloaded.

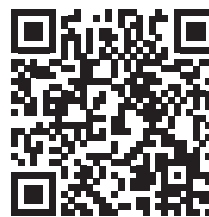

Google play



Download on the App Store



PREHEATING

The DVUT PBE EC and DVUT PBE2 EC units are equipped with an electric preheater to prevent heat exchanger freezing.

REHEATING

The DVUT PBE2 EC units are equipped with electric reheaters to raise the supply air temperature.



BYPASS

The units are equipped with a bypass for summer ventilation.

UNIT CONTROL AND AUTOMATION

Freeze protection

There are two methods of protecting the heat exchanger against freezing in cold conditions. In units without an electric preheater the supply fan is shut down automatically, using the feedback from the extract air temperature sensor, to let the warm extract air thaw the heat exchanger. The supply fan then re-activates and the unit reverts to normal operation. In units with an electric preheater the supply air is warmed up before entering the heat exchanger which prevents freezing. This method ensures a continuous, balanced air exchange.

Function	A21
Wired remote control panel	Option (A22) 
Wired remote sensor control panel	Option (A25) 
Wireless remote control panel	Option (A22 Wi-Fi) 
BMS	RS-485 Wi-Fi Ethernet MODBUS (RTU, TCP)
Vents Cloud Server	+
Control by a mobile application via Wi-Fi	+
Freeze protection	+
Bypass	Auto + manual
Weekly schedule operation	+
Filter maintenance warning	According to filter timer
	According to pressure switch of filter clogging
Alarm indication	+
Speed selection	+
Timer	+
RH% sensor	Option
CO ₂ sensor	Option
VOC sensor	Option
PM2.5 sensor	Option
Boost mode	+
Fireplace mode	+
Preheating	Option
Reheating	Option
Cooler connection	Option
Fire alarm sensor	Option
Supply air temperature control	+

OVERALL DIMENSIONS, MM

Model	D	A	A1	A2	B	B1	H	H1	H2	H3				
DVUT 300 PB EC	200	1547	1155	196	818	873	333	347	145	188				
DVUT 300 PBE EC														
DVUT 300 PBE2 EC			1100		1018			386			400			
DVUT 300 P1B EC														
DVUT 300 P1BE EC			1314		1349			462						
DVUT 300 P1BE2 EC														
DVUT 500 PB EC	250	1806	1316	244	1018	1083	386	400	169	217				
DVUT 500 PBE EC														
DVUT 500 PBE2 EC			1314		1349		462							
DVUT 500 P1B EC														
DVUT 500 P1BE EC			1764		283		1205	-			540	685	-	-
DVUT 500 P1BE2 EC														
DVUT 1000 PB EC	315	2330	1764	283	1205	-	540	685	-	-				

UNIT WITH HORIZONTAL SPIGOTS

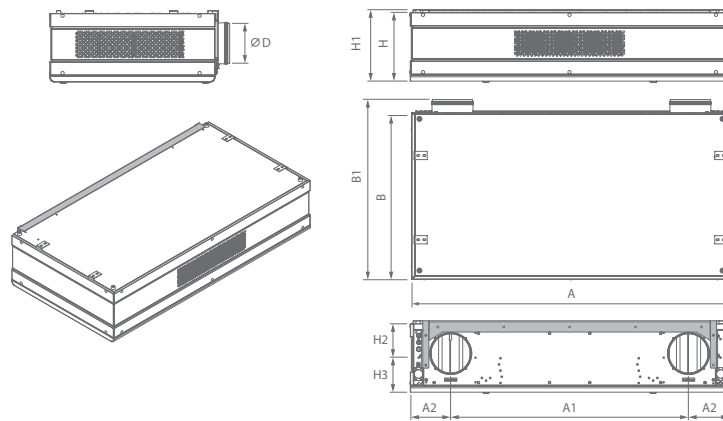

UNIT WITH VERTICAL SPIGOTS

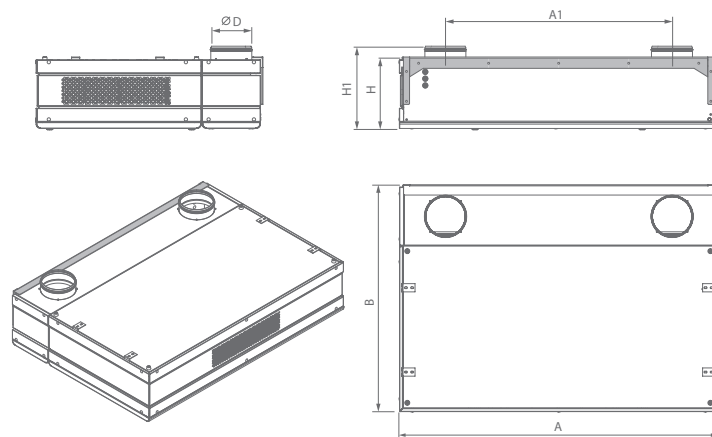

DVUT 1000 PB EC

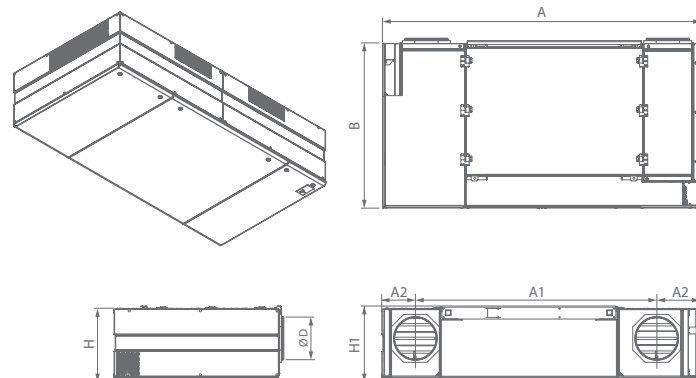

DVUT PB EC

TECHNICAL SPECIFICATIONS

Model		DVUT 300 PB EC	DVUT 300 PBE EC	DVUT 300 PBE2 EC	DVUT 500 PB EC	DVUT 500 PBE EC	DVUT 500 PBE2 EC	DVUT 1000 PB EC	DVUT 1000 PBE EC	DVUT 1000 PBE2 EC		
Supply voltage [V]/50 (60) Hz		1~230						3~400				
Maximum power consumption [W]		125			170			260				
Preheater power [W]		-	1050			-	1750			-	6300	
Reheater power [W]		-	-	1400	-	-	1750	-	-	6300		
Maximum unit current [A]		1,3			1,7			1,85				
Maximum unit current with an electric heater [A]		1,3	7,3	13,6	1,7	10,4	18,2	1,85	11,2	20,5		
Max. air flow rate [m³/h]		300			510			1000				
RPM [min ⁻¹]		2150			1700			2070				
Sound pressure level at 1 m [dBA]		33			34			34				
Sound pressure level at 3 m [dBA]		23			24			24				
Transported air temperature [°C]		-25..+40						-25..+40				
Casing material		polymer coated steel						polymer coated steel				
Insulation		30 mm, polyester						45 mm, polyurethane foam				
Filter	extract	G4						2xG4				
	supply	G4, F8 (Option: F8 + Carbon; H11)						G4x2 + (Option: F7)				
Connected air duct diameter [mm]		Ø 200			Ø 250			Ø 315				
Weight [kg]		78	79	80	103	104	105	267	271	275		
Heat exchange efficiency [%]		76-88			74-86			83-93				
Heat exchanger type		counter-flow										
Heat exchanger material		polystyrene										
SEC class		A						A+				

DVUT 300 PB/PBE/PBE2 EC

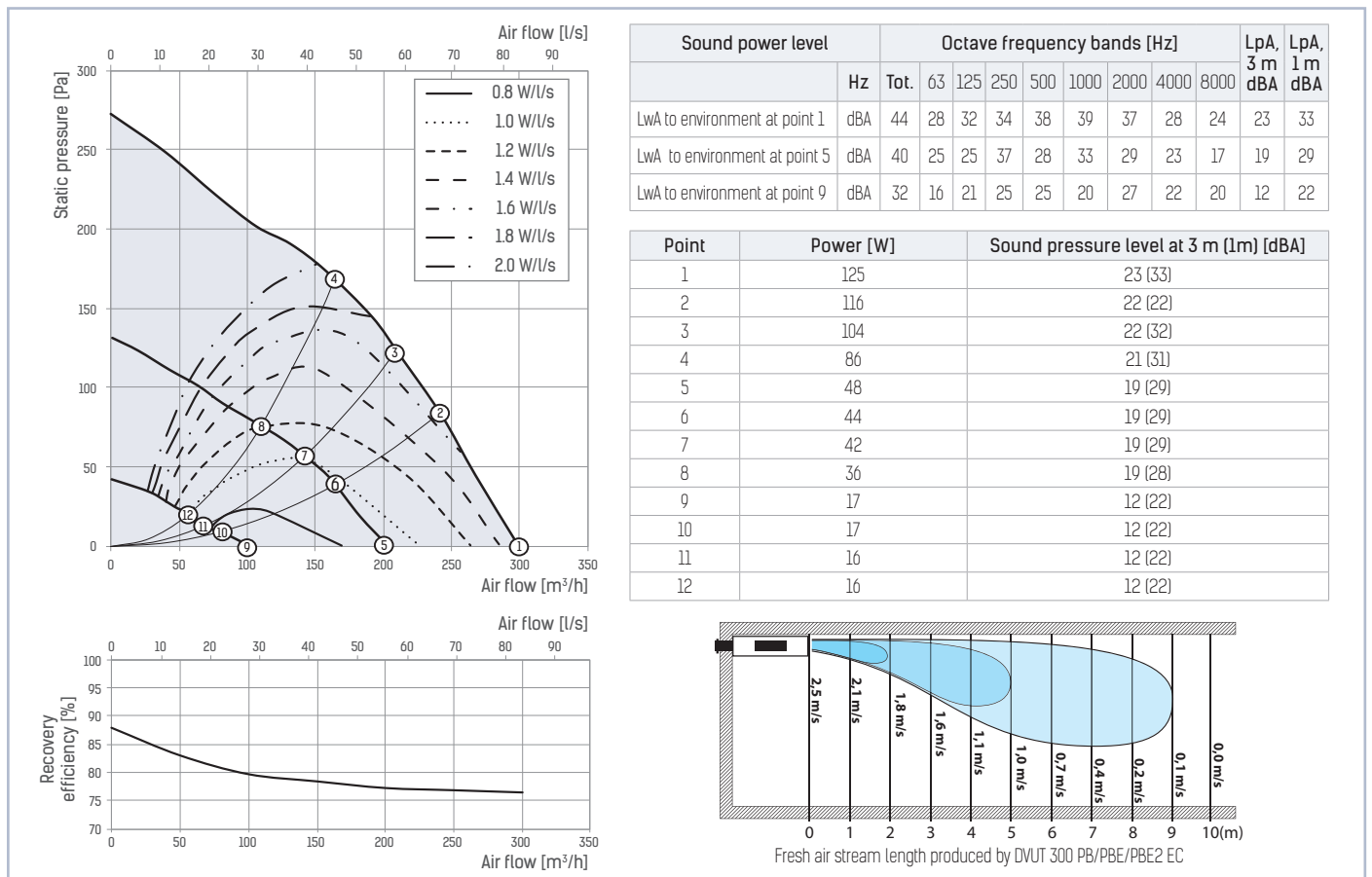

DVUT 500 PB/PBE/PBE2 EC

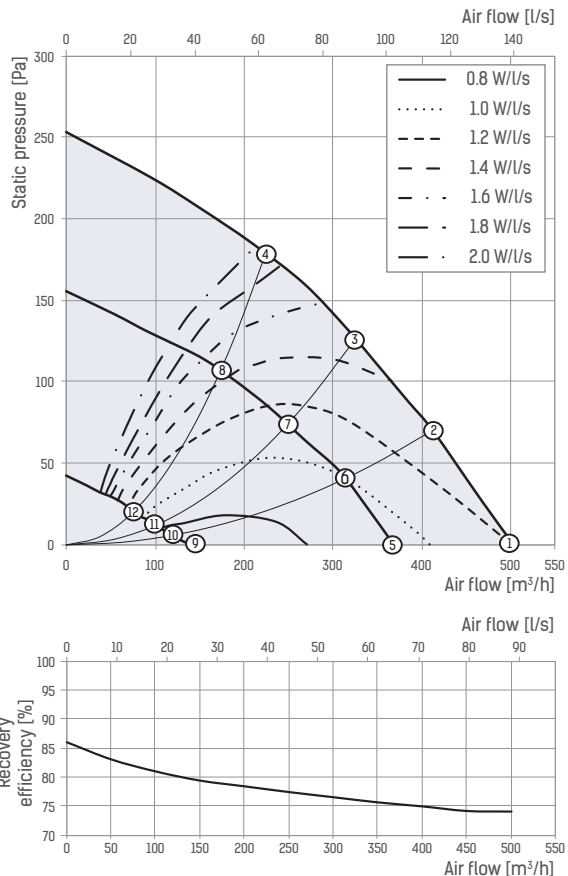

	Sound power level	Octave frequency bands [Hz]								LpA, 3 m dBA	LpA, 1 m dBA	
		Hz	Tot.	63	125	250	500	1000	2000			4000
LwA to environment at point 1	dBA	44	22	28	38	41	37	33	25	14	24	34
LwA to environment at point 5	dBA	40	18	24	32	32	36	28	29	15	19	29
LwA to environment at point 9	dBA	34	10	17	22	21	33	18	18	15	13	23

Point	Power [W]	Sound pressure level at 3 m (1m) [dBA]
1	170	24 (34)
2	153	23 (33)
3	135	23 (33)
4	116	22 (32)
5	95	19 (29)
6	86	19 (29)
7	80	19 (29)
8	68	18 (28)
9	25	13 (23)
10	24	13 (23)
11	24	13 (23)
12	22	13 (23)

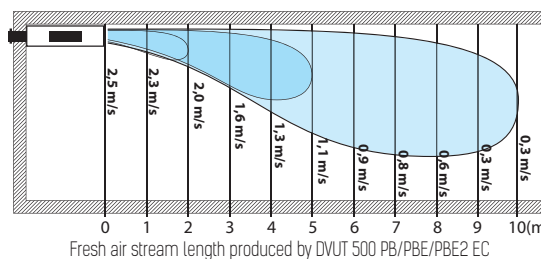

DVUT 1000 PB/PBE/PBE2 EC

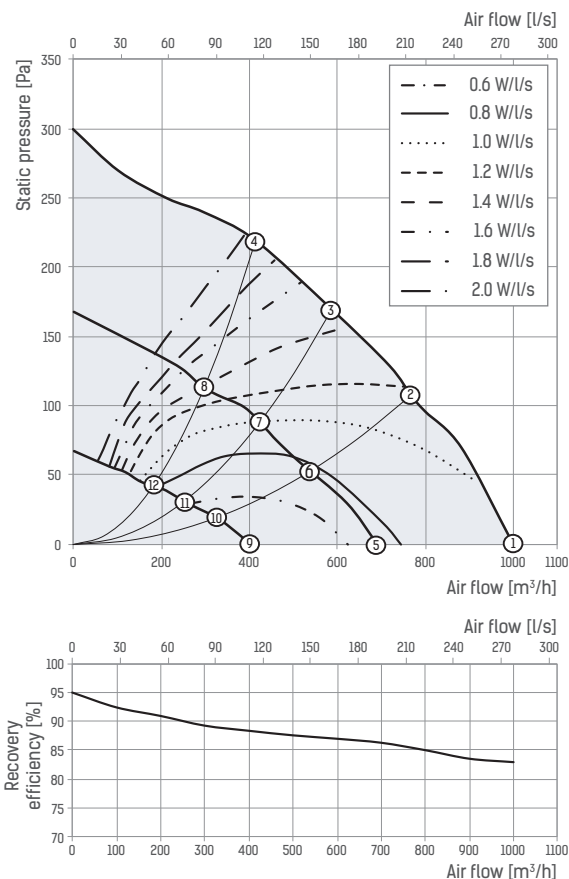





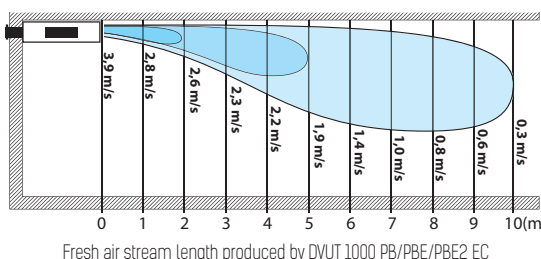

	Sound power level	Octave frequency bands [Hz]								LpA, 3 m dBA	LpA, 1 m dBA	
		Hz	Tot.	63	125	250	500	1000	2000			4000
LwA to environment at point 1	dBA	45	31	37	40	37	36	36	29	18	24	34
LwA to environment at point 5	dBA	37	26	29	32	29	29	29	24	15	17	27
LwA to environment at point 9	dBA	32	21	26	20	25	19	20	25	18	11	21

Point	Power [W]	Sound pressure level at 3 m (1m) [dBA]
1	260	24 (34)
2	251	23 (33)
3	235	23 (33)
4	221	22 (32)
5	136	17 (27)
6	130	17 (27)
7	125	16 (27)
8	120	16 (27)
9	47	11 (21)
10	45	11 (21)
11	44	11 (21)
12	42	11 (21)

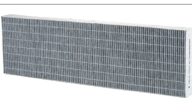

DVUT PB EC

ACCESSORIES

Name	Image	DVUT 300 PB/PBE/PBE2 EC	DVUT 500 PB/PBE/PBE2 EC	DVUT 1000 PB/PBE/PBE2 EC
External grille		MVMA 200 bVn Al	MVMA 250 bVn Al	MVMA 315 bVn Al
G4 panel filter		SF 270x216x48 G4	SF 325x388x48 G4	SF 480x327x48 G4 2 pcs.
G4 panel filter		SF 270x216x48 G4	SF 325x314x48 G4	SF 480x327x48 G4 2 pcs.
F7 panel filter		-	-	SF 480x327x48 F7 2 pcs.
F8 panel filter		SF 270x216x48 F8	SF 325x314x48 F8	-
F8 panel carbon filter		SF 518x270x48 F8 C	SF 714x320x48 F8 C	-
HEPA panel filter		SF 518x270x48 H11	SF 714x320x48 H11	-
VOC sensor (0-10 V)			DPWQ30600	
CO ₂ sensor (0-10 V)			DPWQ40200	
Humidity sensor (0-10V)			DPWC11200	
Humidity sensor (NO)			HR-S	
Humidity sensor			HV-2	
Hydraulic U-trap			SG-32	
Drain pump			DN-2	

SINGLE- ROOM VENTILATION

for schools and public spaces



All the information contained in this catalogue is for reference only.

To improve the quality of its products and ensure production development VENTS reserves the exclusive right to modify the construction, design and specifications as well as alter the components of its products at any time without prior notice.

2022-08

HVI
MEMBER™

