

Series
VENTS VKMz



■ **Applications**

Supply and exhaust ventilation systems for commercial, office and other public or industrial premises. For premises with high requirements to noise level we offer units in low-noise modification (VKMz...Q).

■ **Design**

The fan casing is made of galvanized steel.

■ **Motor**

The impeller with backward curved blades is powered by the single phase motor with external rotor and overheating protection with automatic restart. Some standard sizes are available with high-powered motors (VKMS). The motor is equipped with ball bearings for long service life designed for at least 40000 hours. For precise features, safe operation

and low noise, each turbine is dynamically balanced while assembly. Motor protection rating is IP44.

■ **Speed control**

Smooth or step speed control with a thyristor or autotransformer speed controller. Several fans may be connected to one speed controller provided that the total power and operating current do not exceed the rated speed controller parameters.

■ **Mounting**

Mounting at any angle to wall or ceiling is performed with fastening brackets supplied with the unit. The fan is powered by means of the external terminal box. Electric connection and mounting shall be performed in compliance with the manual and wiring diagram on the terminal box.

Inline centrifugal fans in galvanized casing with the air flow up to **1540 m³/h**

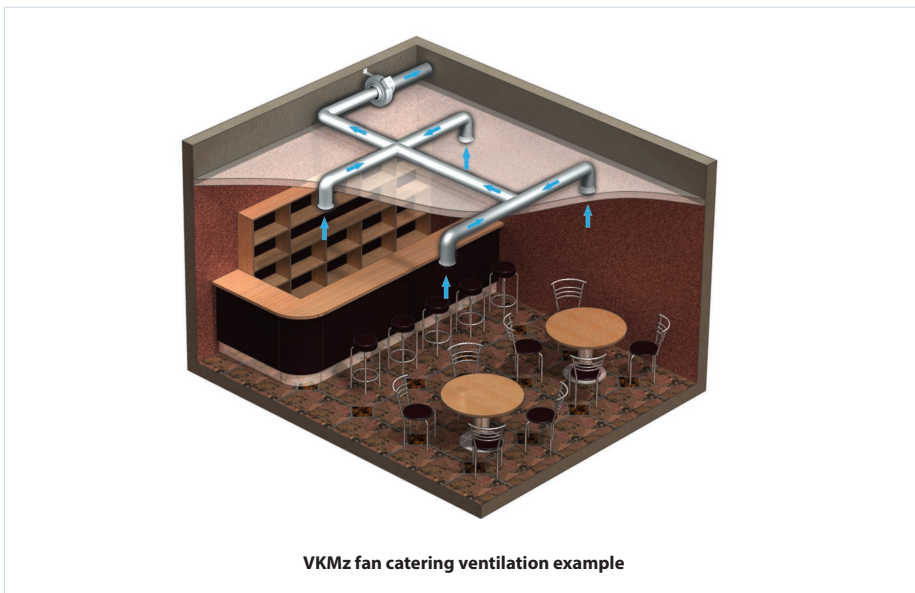

VKMz fan catering ventilation example

Designation key

Series		Air duct diameter	Options
VENTS VKMz	S: high-powered motor	100; 125; 150; 160; 200; 250; 315	Q: low-powered motor. R1: power cord with a mains plug.

Accessories



Silencer

Filters

Heaters

Backdraft damper

Air shutter

Clamp

Speed controllers

Technical data

	VKMz 100 Q		VKMz 100		VKMz 125 Q		VKMz 125		VKMz 150		VKMSz 150	
Voltage, [V]	1~220-240		1~220-240		1~220-240		1~220-240		1~220-240		1~220-240	
Frequency [Hz]	50	60	50	60	50	60	50	60	50	60	50	60
Power [W]	42	51	62	77	60	61	78	79	64	78	127	174
Current [A]	0.19	0.23	0.28	0.34	0.37	0.37	0.34	0.34	0.29	0.34	0.56	0.77
Max. air flow [m³/h]	230	250	250	265	230	240	330	340	455	475	710	750
RPM [min ⁻¹]	2732	3258	2812	3294	2605	2720	2820	2880	2780	3216	2760	3144
Noise level at 3 m [dBA]	35	36	46	47	35	36	46	46	44	45	48	49
Transported air temperature [°C]	-25...+55	-25...+50	-25...+55	-25...+50	-25...+55	-25...+50	-25...+55	-25...+50	-25...+50	-25...+50	-25...+60	-25...+60
SEC class	C		C		C		C		C		-	C
Unit protection rating	IPX4		IPX4		IPX4		IPX4		IPX4		IPX4	
Motor protection rating	IP44		IP44		IP44		IP44		IP44		IP44	

To meet the requirements of ErP 2018, a speed controller and local demand control typology must be applied (connect a sensor).

	VKMz 160		VKMz 200 Q		VKMz 200		VKMSz 200		VKMz 250 Q		VKMz 250		VKMz 315 Q		VKMz 315	
Voltage, [V]	1~220-240		1~220-240		1~220-240		1~220-240		1~220-240		1~220-240		1~220-240		1~220-240	
Frequency [Hz]	50	60	50	60	50	60	50	60	50	60	50	60	50	60	50	60
Power [W]	78	81	130	174	144	193	186	240	134	175	152	202	151	205	185	238
Current [A]	0.34	0.35	0.56	0.77	0.63	0.85	0.81	1.05	0.59	0.77	0.66	0.88	0.66	0.89	0.81	1.04
Max. air flow [m³/h]	455	460	900	970	1000	1045	1110	1140	980	1030	1070	1100	1330	1370	1540	1580
RPM [min ⁻¹]	2760	2820	2814	3558	2824	3164	2810	3222	2785	2880	2765	2560	2680	2750	2730	2870
Noise level at 3 m [dBA]	46	46	48	49	50	50	50	50	51	51	52	52	52	52	53	54
Transported air temperature [°C]	-25...+55	-25...+50	-25...+50				-25...+50				-25...+50		-25...+50		-25...+45	
SEC class	B		B		B		B		B		B		-		-	
Unit protection rating	IPX4		IPX4		IPX4		IPX4		IPX4		IPX4		IPX4		IPX4	
Motor protection rating	IP44		IP44		IP44		IP44		IP44		IP44		IP44		IP44	

To meet the requirements of ErP 2018, a speed controller and local demand control typology must be applied (connect a sensor).

Fan overall dimensions

Type	Dimensions [mm]								Mass [kg]
	∅D	∅D1	B	B1	L	L1	L2	L3	
VKMz 100 Q	98	237	253	293	202	23	22	30	2.5
VKMz 100	98	237	253	293	202	23	22	30	2.8
VKMz 125 Q	123	237	253	293	202	23	22	30	2.7
VKMz 125	123	237	253	293	202	23	22	30	2.9
VKMz 150	149	274	290	330	170	20	20	30	3.2
VKMSz 150	149	345	355	395	230	20	20	40	4.8
VKMz 160	158	278	294	334	200	25	23	30	3.2
VKMz 200 Q	198	339	355	380	245	25	29	40	5.5
VKM(S)z 200	198	339	355	395	245	25	29	40	5.8
VKMz 250 Q	249	332	340	395	213	25	29	40	5.1
VKMz 250	249	332	340	380	213	25	29	40	5.1
VKMz 315 Q	313	402	410	450	308	33	55	40	6.5
VKMz 315	313	402	410	450	308	33	55	40	6.5

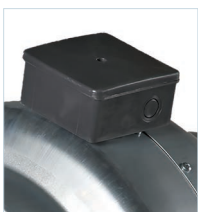
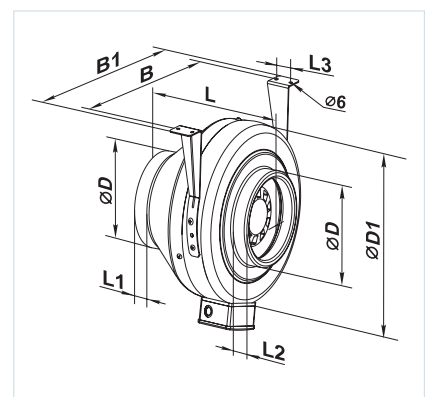

External terminal box for power supply



Fastening bracket for easy mounting supplied with the fan



VENTS VKMz...R is equipped with a power cable

VENTS VKMz

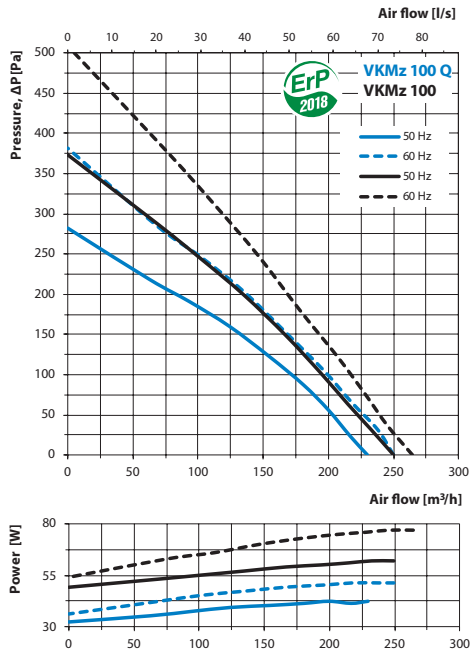

VKMz 100 Q

Sound-power level	Hz	Gen	Octave-frequency band [Hz]							
			63	125	250	500	1000	2000	4000	8000
L _{WA} to inlet	dBA	63	51	57	56	57	51	46	40	29
L _{WA} to outlet	dBA	65	54	62	58	61	57	50	45	33
L _{WA} to environment	dBA	55	19	14	21	34	42	41	29	17

VKMz 100

Sound-power level	Hz	Gen	Octave-frequency band [Hz]							
			63	125	250	500	1000	2000	4000	8000
L _{WA} to inlet	dBA	72	47	67	68	67	60	54	53	42
L _{WA} to outlet	dBA	73	56	67	72	66	63	58	57	42
L _{WA} to environment	dBA	64	43	60	57	41	24	6	17	24

VENTS VKMz

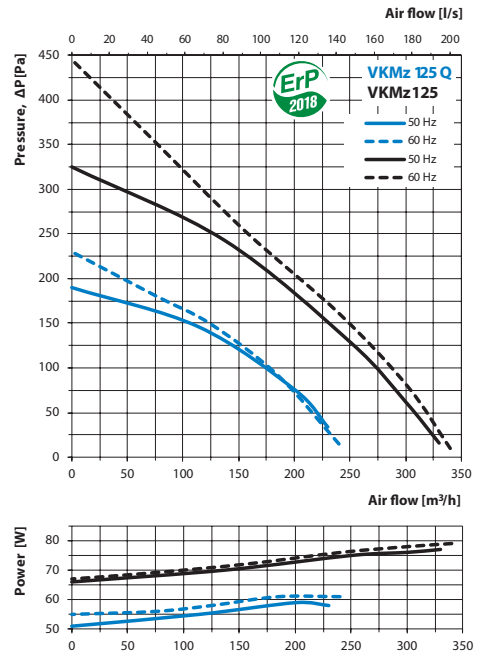

VKMz 125 Q

Sound-power level	Hz	Gen	Octave-frequency band [Hz]							
			63	125	250	500	1000	2000	4000	8000
L _{WA} to inlet	dBA	59	31	52	54	53	49	46	35	30
L _{WA} to outlet	dBA	61	35	53	56	60	51	49	35	34
L _{WA} to environment	dBA	64	46	60	59	43	33	15	30	28

VKMz 125

Sound-power level	Hz	Gen	Octave-frequency band [Hz]							
			63	125	250	500	1000	2000	4000	8000
L _{WA} to inlet	dBA	75	56	63	68	69	64	61	52	41
L _{WA} to outlet	dBA	75	58	71	74	72	65	65	56	47
L _{WA} to environment	dBA	64	52	64	59	48	36	23	30	27

VENTS VKMz

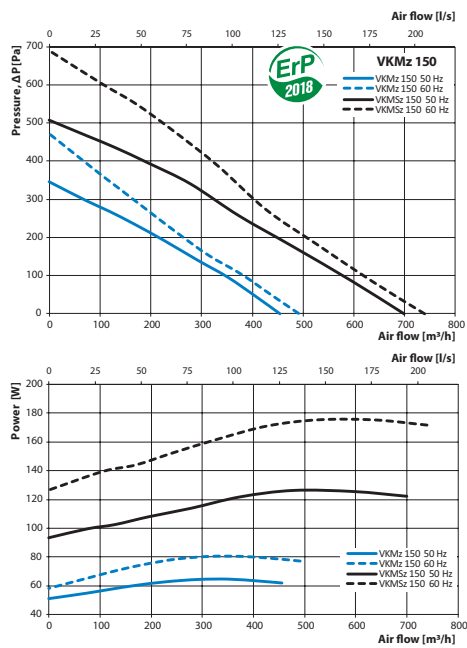

VKMz 150

Sound-power level	Hz	Gen	Octave-frequency band [Hz]								LpA, 3 m dBA	LpA, 1 m dBA
			63	125	250	500	1000	2000	4000	8000		
L _{WA} to inlet	dBA	80	57	72	78	70	64	60	54	44	59	69
L _{WA} to outlet	dBA	79	64	72	77	69	61	57	53	42	58	68
L _{WA} to environment	dBA	60	28	48	50	55	56	52	43	33	40	50

VKMz 150

Sound-power level	Hz	Gen	Octave-frequency band [Hz]								LpA, 3 m dBA	LpA, 1 m dBA
			63	125	250	500	1000	2000	4000	8000		
L _{WA} to inlet	dBA	94	56	91	90	79	78	75	71	57	74	84
L _{WA} to outlet	dBA	94	56	92	89	76	75	69	68	55	74	84
L _{WA} to environment	dBA	68	29	51	61	63	63	63	52	39	48	58

VENTS VKMz

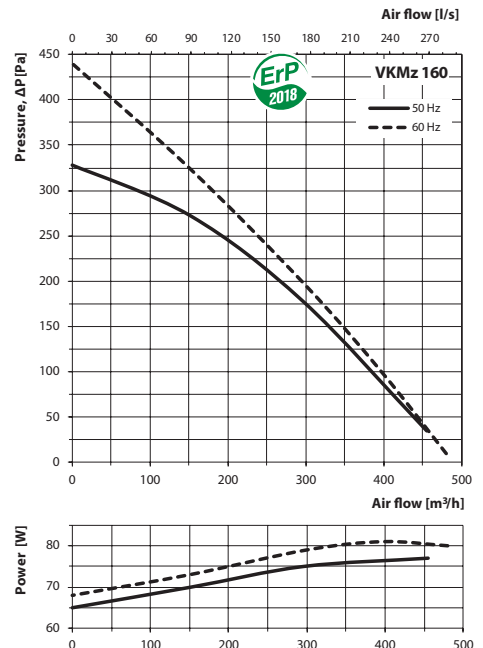

VKMz 160

Sound-power level	Hz	Gen	Octave-frequency band [Hz]							
			63	125	250	500	1000	2000	4000	8000
L _{WA} to inlet	dBA	69	42	67	66	63	61	58	48	35
L _{WA} to outlet	dBA	72	46	69	65	68	64	63	50	40
L _{WA} to environment	dBA	60	41	60	53	36	20	18	30	24

